

**Case CS/CS Pro 78-105**  
**Steyr 8000/9000/M/MT**

**Konzola standardní**

**Cena: 668,- EUR** 00.105.00.1



**Konzola dlouhá, 9 poloh**

**Cena: 826,- EUR** 00.105.03.3

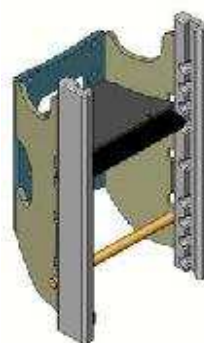

**Konzola s pitonfixem  
a přípravou na tažnou tyč**

**Cena: 981,- EUR** 00.105.70.1

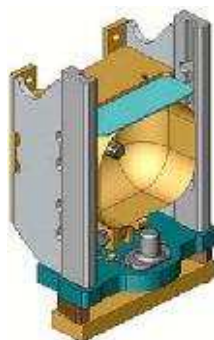

**Tažná tyč**

**Cena: 435,- EUR** 00.809.00.0

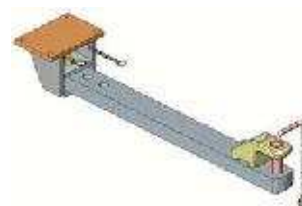

**Konzola s koulí K-80**

**Cena: 1 824,- EUR** 00.105.80.2



## Case CS/CS Pro 78-105 Steyr 8000/9000/M/MT

**Hák vč. výměnné koncovky s tažnou tyčí**

**Cena: 2 477,- EUR** 00.412.50.0

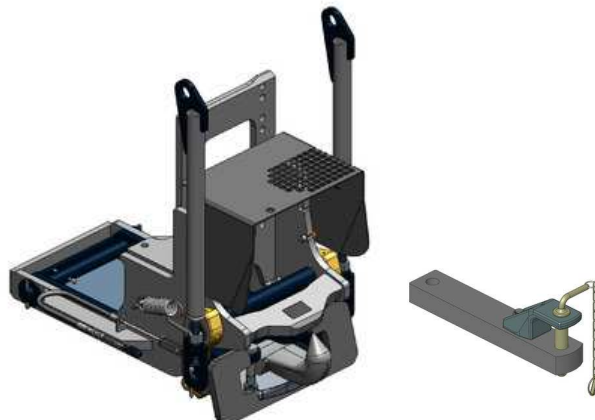

**Koule K-80 do konzoly, 2 polohová**

**Cena: 970,- EUR** 05.6325.33

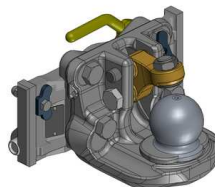

**Pitonfix do konzoly**

**Cena: 865,- EUR** 05.6325.10

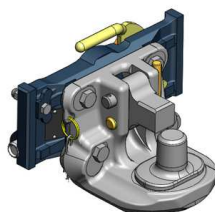

**Koule K-50**

**Cena: 640,- EUR** 05.7325.03

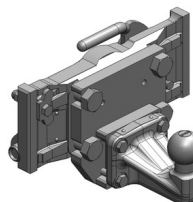

**Hubice mechanická  
s kolíkem ø 30 nebo 38 mm**

**Cena: 470,- EUR**  
05.3255.01

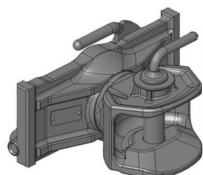

**Hubice automatická  
s kolíkem ø 30 mm**

**AKCE: 400,- EUR**  
05.3251.32

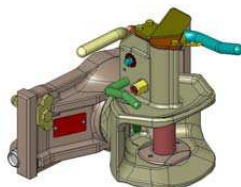

**Hubice automatická  
s kolíkem ø 38 mm**

**Cena: 840,- EUR**  
05.3253.321

