

Case CVX a CS 110-150 Steyr CVT a 9100

Konzola standardní, 8 poloh

Cena: **854,- EUR** 00.110.05.0

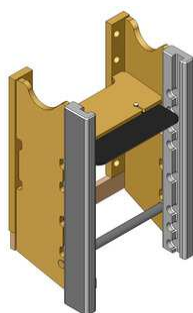

Konzola standardní, 9 poloh

Cena: **1 089,- EUR** 00.110.05.2

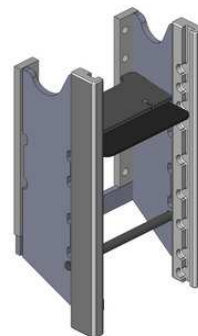

Konzola krátká kompatibilní s hákem, 5 poloh

Cena: **668,- EUR** 00.110.15.0

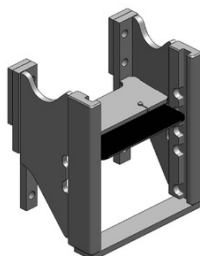

Konzola s přípravou pro tažnou tyč nebo spodní plato

Cena: **981,- EUR** 00.110.55.0

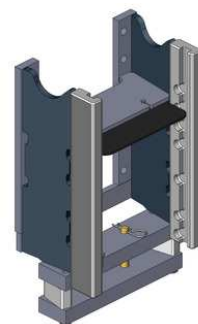

Konzola s pitonfixem a přípravou pro tažnou tyč nebo spodní plato

Cena: **1 292,- EUR** 00.110.75.0

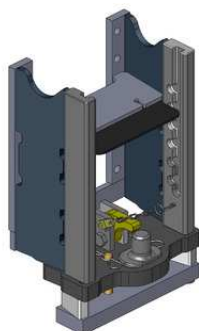

Tažná tyč standard

Cena: **507,- EUR** 00.807.01.0



Case CVX a CS 110-150 Steyr CVT a 9100

Konzola s koulí K-80 standard W325

8 poloh: 1 583,- EUR 00.110.84.2
9 poloh: 1 756,- EUR 00.110.87.0

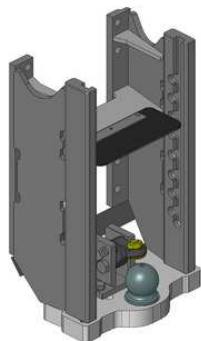

Konzola s koulí K-80, W330

Cena: 1 583,- EUR 00.110.84.4

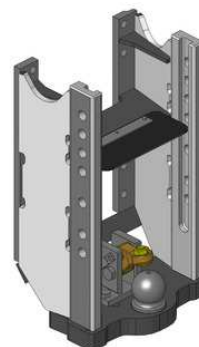

Konzola s koulí K-80, W325, automatické zajištění K-80

Cena: 1 756,- EUR 00.110.88.0

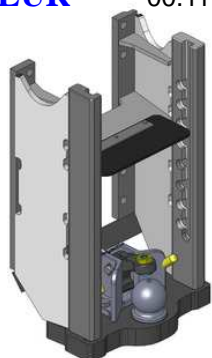

Tažná tyč pro konzolu s K-80

Cena: 663,- EUR 00.807.10.0

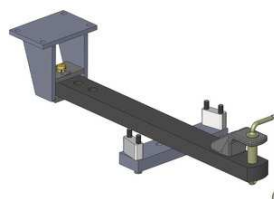

Spodní plato s koulí K-80, 3-polohové

Cena: 1 588,- EUR 00.960.290.3

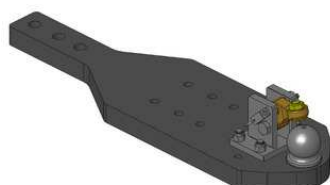

Spodní plato s pitonfixem, 3-polohové

Cena: 1 202,- EUR 00.961.290.2

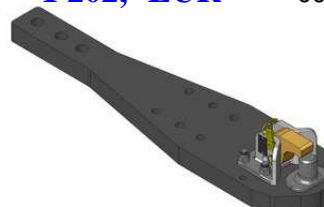

Oboustranné nucené řízení s K-50 pro spodní plato s K-80

Cena: 787,- EUR 00.521.0320.0

Nucené řízení jen pravé nebo levé

Cena: 489,- EUR

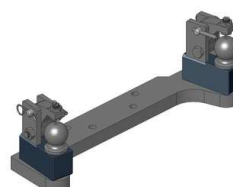

Case CVX a CS 110-150 Steyr CVT a 9100

Hák hydraulický vč. koncovky tažné tyče

Cena: 3 688,- EUR 00.400.52.3

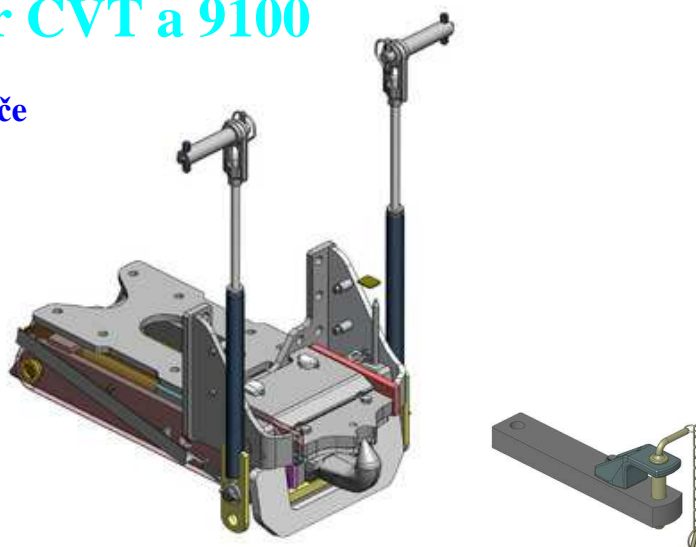

Vložka K-80 do háku, zatížení 3 t

Cena: 1 600,- EUR 00.423.00.0

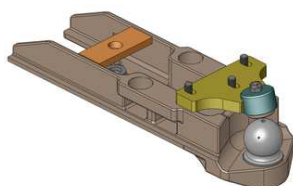

**Vložka K-80 do háku, zatížení 2 t,
možnost připojení nuceného řízení**

Cena: 981,- EUR 00.427.01.0

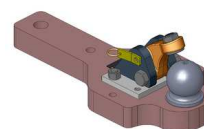

Koule K-80 do konzoly, 2 polohová

Cena: 970,- EUR 05.6325.33

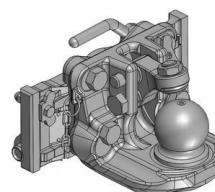

Pitonfix do konzoly

Cena: 865,- EUR 05.6325.10

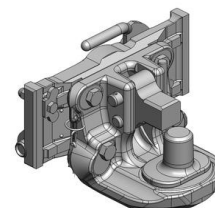

**Mechanická hubice
s kolíkem ø 30 nebo 38 mm**

Cena: 470,- EUR
05.3255.01

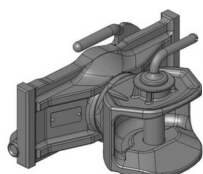

**Hubice automatická
s kolíkem ø 30 mm**

AKCE: 400,- EUR
05.3251.32

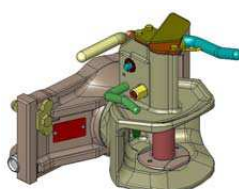

**Hubice automatická
s kolíkem ø 38 mm**

Cena: 840,- EUR
05.3253.321

