

## Case Farmall U-Pro-EP 95-115, Steyr Multi 4095-4115 Case Luxxum 100-120, Steyr Multi 4100-4120

### Konzola standardní

**Cena: 843,- EUR**      00.104.00.2

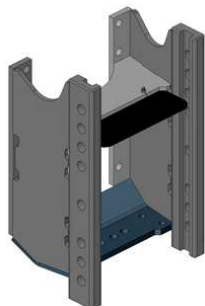

### Konzola prodloužená

**Cena: 996,- EUR**      00.104.21.0 (nahoru)

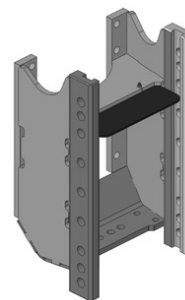

### Konzola kompatibilní s hákem

**Cena: 668,- EUR**      00.104.10.0

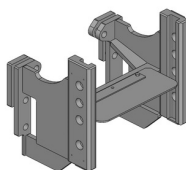

### Tažná tyč, sada

**Cena: 608,- EUR**      00.823.00.1

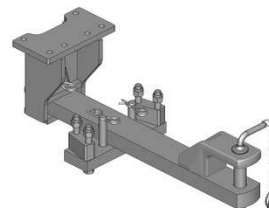

### Hák mechanický vč. tažné tyče, svislé zatížení 2 t

**Cena: 2 691,- EUR**      00.412.55.0

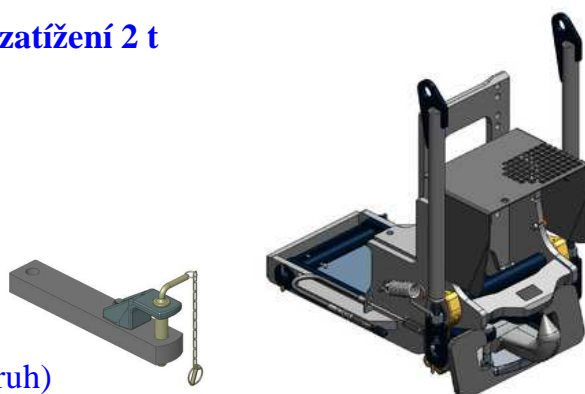

(k ovládní není potřeba hydraulický okruh)

### Hák hydraulický vč. tažné tyče, svislé zatížení 3 t

**Cena: 3 925,- EUR**      00.412.61.0

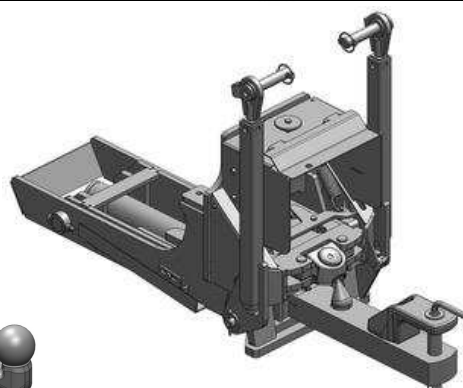

### Vložka K-80 do háku

**Cena: 779,- EUR**      00.427.11.0

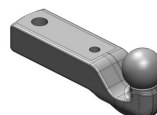

## Case Farmall U-Pro-EP 95-115, Steyr Multi 4095-4115 Case Luxxum 100-120, Steyr Multi 4100-4120

### Spodní plato s pitonfixem, upravit

Cena: **464,- EUR** 00.961.031.0

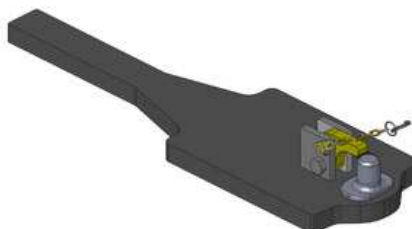

### Spodní plato s koulí K-80, upravit

Cena: **818,- EUR** 00.960.011.0

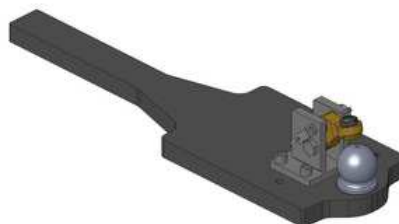

### Koule K-50 do konzoly

Cena: **640,- EUR** 07.7330.04

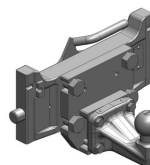

### Koule K-80 do konzoly, dvoudílná

Cena: **920,- EUR** 07.6330.42

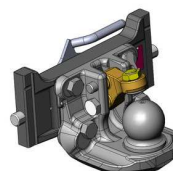

### Pitonfix do konzoly, dvoudílný

Cena: **730,- EUR** 07.6330.32

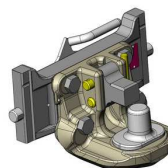

### Koule K-80 do konzoly, jednodílná, bez automatického zajištění, svislé zatížení 4 t

Cena: **740,- EUR** 05.6330.51

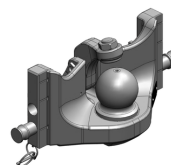

### Pitonfix do konzoly, jednodílný bez automatického zajištění

Cena: **580,- EUR** 05.6330.16

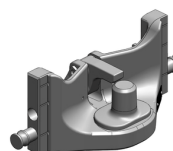

**Case Farmall U-Pro-EP 95-115, Steyr Multi 4095-4115  
Case Luxxum 100-120, Steyr Multi 4100-4120**

**Hubice mechanická  
s kolíkem ø 30 nebo 38 mm**

**Cena: 543,- EUR**  
03.3305.06

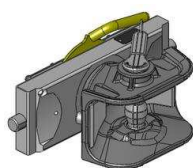

**Hubice automatická  
s kolíkem ø 30 mm**

**Cena: 780,- EUR**  
03.3301.221

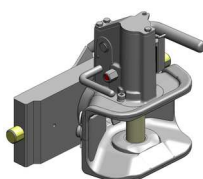

**Hubice automatická  
s kolíkem ø 38 mm**

**Cena: 780,- EUR**  
03.3303.221

