

Case Farmall U-Pro-EP 95-115, Steyr Multi 4095-4115 Case Luxxum 100-120, Steyr Multi 4100-4120

Konzola standardní

Cena: **843,- EUR** 00.104.00.2

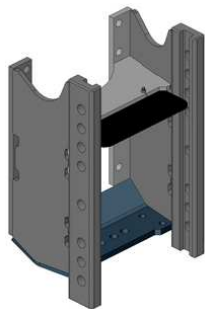

Konzola prodloužená

Cena: **996,- EUR** 00.104.21.0 (nahoru)

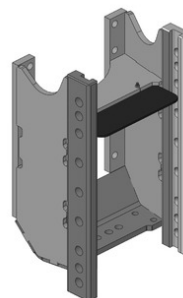

Konzola kompatibilní s hákem

Cena: **668,- EUR** 00.104.10.0

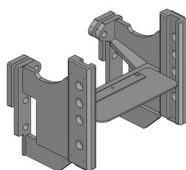

Tažná tyč, sada

Cena: **608,- EUR** 00.823.00.1

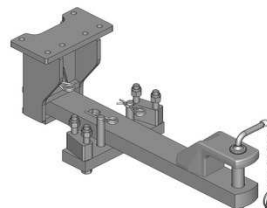

Hák mechanický vč. tažné tyče, svislé zatížení 2 t

Cena: **2 153,- EUR** 00.412.55.0

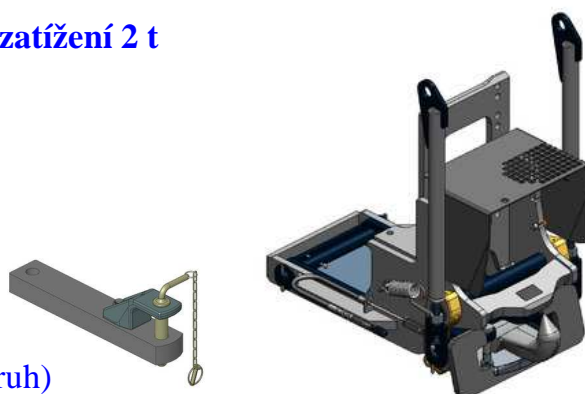

(k ovládání není potřeba hydraulický okruh)

Hák hydraulický vč. tažné tyče, svislé zatížení 3 t

Cena: **3 729,- EUR** 00.412.61.0

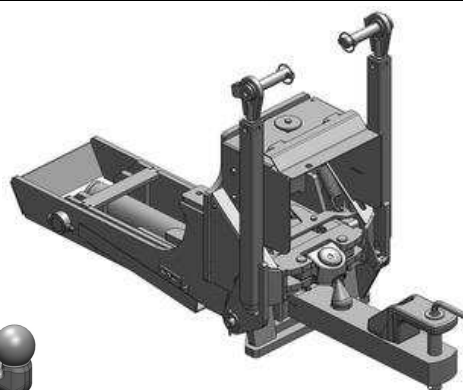

Vložka K-80 do háku

Cena: **779,- EUR** 00.427.11.0

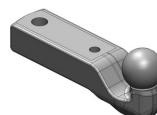

Case Farmall U-Pro-EP 95-115, Steyr Multi 4095-4115 Case Luxxum 100-120, Steyr Multi 4100-4120

Spodní plato s pitonfixem, upravit

Cena: 464,- EUR 00.961.031.0

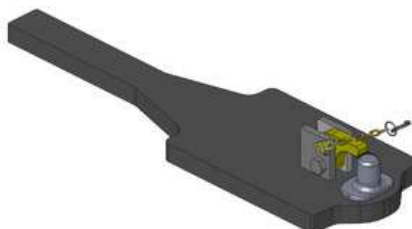

Spodní plato s koulí K-80, upravit

Cena: 818,- EUR 00.960.011.0

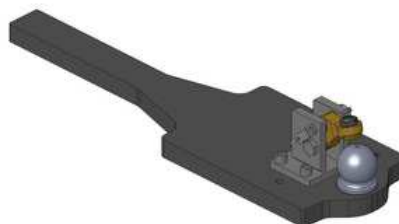

Koule K-50 do konzoly

Cena: 640,- EUR 07.7330.04

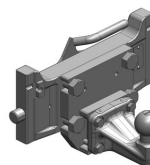

Koule K-80 do konzoly, dvoudílná

Cena: 920,- EUR 07.6330.42

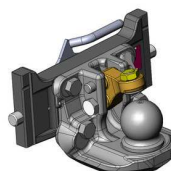

Pitonfix do konzoly, dvoudílný

Cena: 730,- EUR 07.6330.32

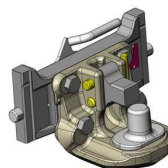

**Koule K-80 do konzoly, jednodílná,
bez automatického zajištění, svislé zatížení 4 t**

Cena: 740,- EUR 05.6330.51

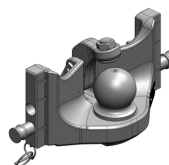

**Pitonfix do konzoly, jednodílný
bez automatického zajištění**

Cena: 580,- EUR 05.6330.16

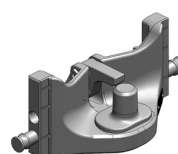

**Case Farmall U-Pro-EP 95-115, Steyr Multi 4095-4115
Case Luxxum 100-120, Steyr Multi 4100-4120**

**Hubice mechanická
s kolíkem ø 30 nebo 38 mm**

Cena: 543,- EUR
03.3305.06

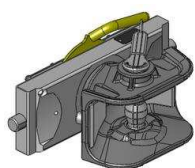

**Hubice automatická
s kolíkem ø 30 mm**

Cena: 780,- EUR
03.3301.221

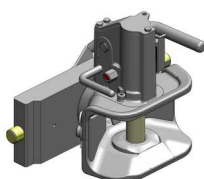

**Hubice automatická
s kolíkem ø 38 mm**

Cena: 780,- EUR
03.3303.221

