

Case MXU, Maxxum a Maxxum CVX, Puma a Puma CVX 125-160 (vč. EP)  
Steyr Profi 4100-6145, Profi 4110-4145 CVT, CVT 6130-6160 (vč. EcoTech)

**Konzola standardní (8 poloh), W330**

**Cena: 1 011,- EUR** 00.116.08.1

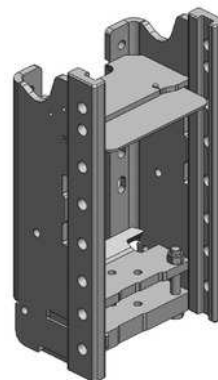

**Konzola kompatibilní s hákem  
CNH i Scharmüller (6 poloh), W330**

**Cena: 668,- EUR** 00.111.11.0

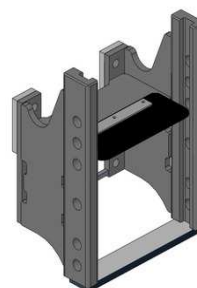

**Konzola s pitonfixem, W330**

**Cena: 1 479,- EUR** 00.116.71.2



**Konzola s koulí K-80**

**W330: 1 824,- EUR** 00.116.81.2

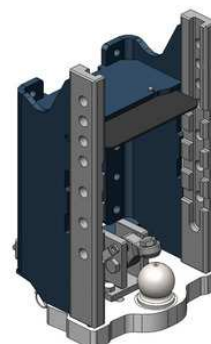

**Case MXU, Maxxum a Maxxum CVX, Puma a Puma CVX 125-160 (vč. EP)  
Steyr Profi 4100-6145, Profi 4110-4145 CVT, CVT 6130-6160 (vč. EcoTech)**

**Spodní plato s koulí K-80, pro originální konzolu CNH**

**Cena: 1 211,- EUR** 00.960.593.2

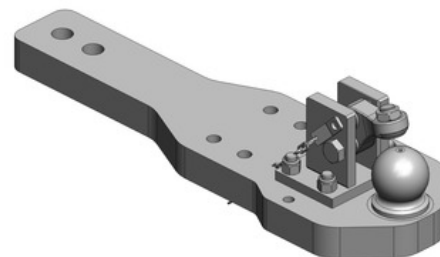

(vč. Maxxum 150 Tier 4b)

**Spodní plato s koulí K-80, pro originální konzolu CNH**

**Cena: 1 545,- EUR** 00.960.594.1-SET1

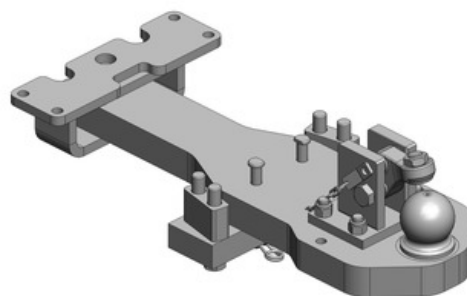

(vč. držáků uvedených na obrázku)  
(pro modely Profi EcoTech 4110-6140, Maxxum 110-140 EP, Maxxum CVX)  
(NE pro modely Profi EcoTech 4115-6145 vč. CVT, Maxxum 115-150 Tier 4b vč. CVX)

**Spodní plato s koulí K-80, pro originální konzolu CNH**

**Cena: 1 545,- EUR** 00.960.594.1-SET2

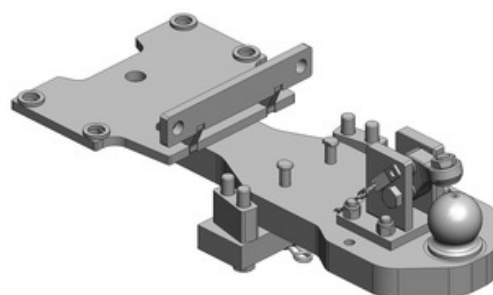

(vč. držáků uvedených na obrázku)  
(pro modely CVT EcoTech 6130-6160, Puma EP a Puma CVX EP 125-160)

**Spodní plato s koulí K-80, pro originální konzolu CNH  
(i tu s pitonfixem)**

**Cena: 1 487,- EUR** 00.960.597.3

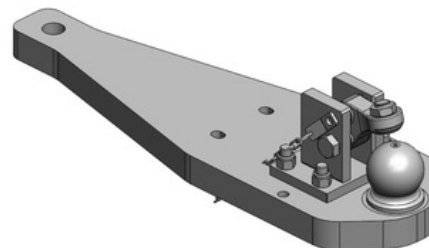

(pro modely CVT EcoTech 6130-6160, Puma EP a Puma CVX EP 125-160)

**Case MXU, Maxxum a Maxxum CVX, Puma a Puma CVX 125-160 (vč. EP)  
Steyr Profi 4100-6145, Profi 4110-4145 CVT, CVT 6130-6160 (vč. EcoTech)**

**Spodní plato s koulí K-80, upravit**

**Cena: 818,- EUR – 40 mm** 00.960.011.0  
**867,- EUR – 45 mm** 00.960.010.0

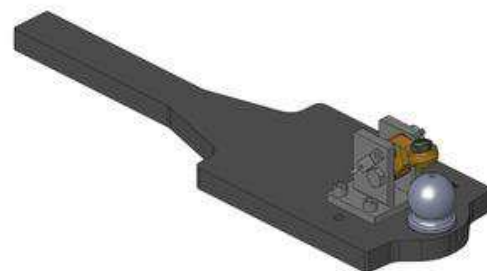

**Spodní plato s pitonfixem, upravit**

**Cena: 792,- EUR – 40 mm** 00.961.041.0  
**825,- EUR – 45 mm** 00.961.043.0

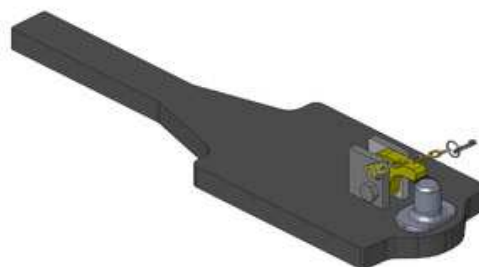

**Tažná tyč**

**Cena: 608,- EUR** 00.807.45.0  
**551,- EUR** 00.807.47.0

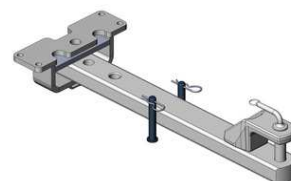

**Oboustranné nucené řízení s K-50 pro spodní plato s K-80**

**Cena: 787,- EUR** 00.521.0320.0

**Nucené řízení jen pravé nebo levé**

**Cena: 489,- EUR**

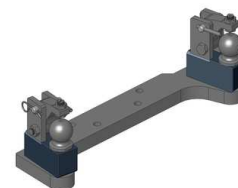

**Case MXU, Maxxum a Maxxum CVX, Puma a Puma CVX 125-160 (vč. EP)**  
**Steyr Profi 4100-6145, Profi 4110-4145 CVT, CVT 6130-6160 (vč. EcoTech)**

**Koule K-80 pro konzolu**

<b>originál CNH:</b>	<b>990,- EUR</b>	03.6320.46
<b>W330:</b>	<b>920,- EUR</b>	07.6330.42

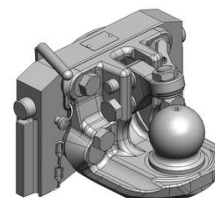

**Pitonfix pro konzolu**

<b>originál CNH:</b>	<b>800,- EUR</b>	03.6320.25
<b>W330:</b>	<b>730,- EUR</b>	07.6330.32

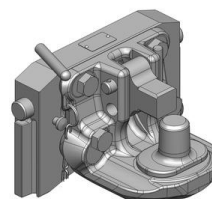

**Koule K-80 pro standardní konzolu W330,  
neautomatické zajištění, svislé zatížení 4 t**

<b>Cena:</b>	<b>740,- EUR</b>	05.6330.51
--------------	------------------	------------

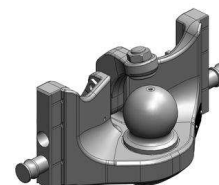

**Pitonfix pro standardní konzolu W330,  
neautomatické zajištění**

<b>Cena:</b>	<b>580,- EUR</b>	05.6330.16
--------------	------------------	------------

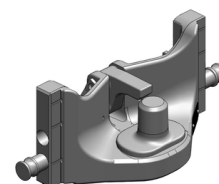

**Koule K-50 pro konzolu**

<b>originál CNH:</b>	<b>640,- EUR</b>	03.7320.04
<b>W330:</b>	<b>640,- EUR</b>	07.7330.04

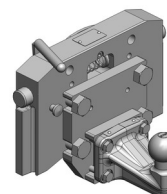

**Case MXU, Maxxum a Maxxum CVX, Puma a Puma CVX 125-160 (vč. EP)  
Steyr Profi 4100-6145, Profi 4110-4145 CVT, CVT 6130-6160 (vč. EcoTech)**

**Hubice mechanická  
s kolíkem ø 30 nebo 38 mm pro konzolu**

<b>originál CNH:</b>	<b>543,- EUR</b>	03.3205.06
<b>W330:</b>	<b>543,- EUR</b>	03.3305.06
<b>W325:</b>	<b>543,- EUR</b>	05.3255.06

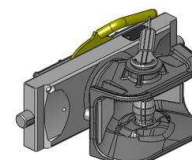

---

**Hubice automatická  
s kolíkem ø 30 mm pro konzolu**

<b>originál CNH:</b>	<b>880,- EUR</b>	03.6320.431
<b>W330:</b>	<b>780,- EUR</b>	03.3301.221
<b>W325:</b>	<b>840,- EUR</b>	05.3251.321

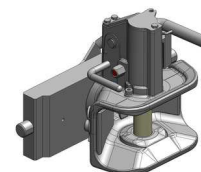

---

**Hubice automatická  
s kolíkem ø 38 mm pro konzolu**

<b>originál CNH:</b>	<b>880,- EUR</b>	03.6320.531
<b>W330:</b>	<b>780,- EUR</b>	03.3303.221
<b>W325:</b>	<b>840,- EUR</b>	05.3253.321

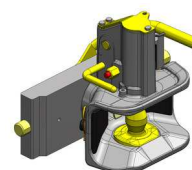

**Case MXU, Maxxum a Maxxum CVX, Puma a Puma CVX 125-160 (vč. EP)  
Steyr Profi 4100-6145, Profi 4110-4145 CVT, CVT 6130-6160 (vč. EcoTech)**

**Hydraulický hák vč. tažné tyče**

**Cena: 3 570,- EUR** 00.400.70.2

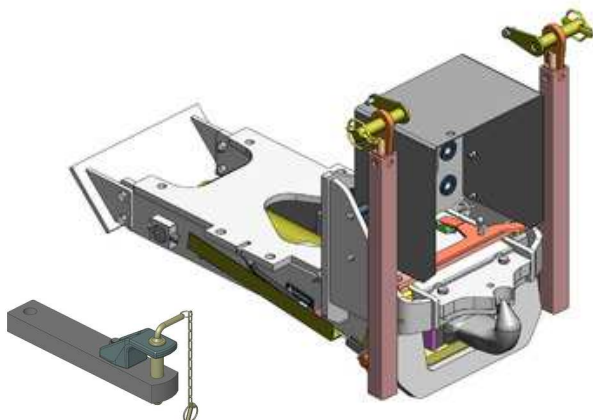

(Pouze pro MXU, Maxxum vč. EP a CVX,  
Profi 4100-6140 vč. EcoTech a 4110-4130 CVT)

**Hydraulický hák vč. tažné tyče a vč. zkrácené konzoly pro horní závěs (W330)**

**Cena: 4 702,- EUR** 00.400.83.0

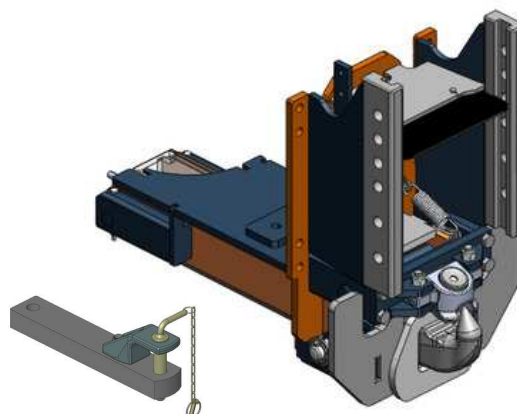

(Pouze pro Puma/Puma CVX 125-160 vč. EP,  
CVT EcoTech 6130-6160)

**Vložka K-80 do háku 00.400.70.2, zatížení 3 t**

**Cena: 1 444,- EUR** 00.423.00.0

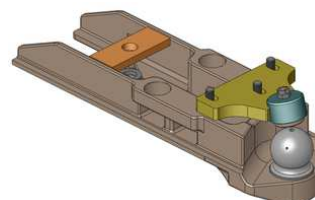

**Vložka K-80 do háku 00.400.70.2, zatížení 2 t,  
možnost připojení nuceného řízení**

**Cena: 981,- EUR** 00.427.01.0

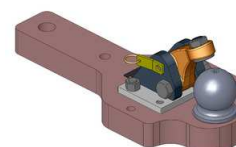

**Vložka K-80 do háku 00.400.83.0, svislé zatížení 4 t**

**Cena: 840,- EUR** 10.866.500.0

