

Case ostatní modely Spodní plata s koulí K-80 a K-110

Adaptér s K-80 pro tažnou tyč CNH 87609238

(rozměr 128 x 64 x ø 52 mm)

pro Quadrac EP 450-620, Steiger 350-620, STX 385-535

Cena: 1 511,- EUR 02.481.701

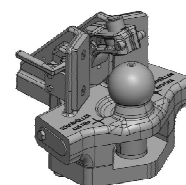

Nucené řízení

Levé: 381,- EUR 00.520.65.0

Pravé: 381,- EUR 00.520.66.0

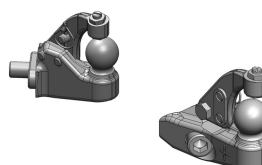

K-80 pro Steiger EP a Quadrac EP (Tier 4B) (pro Large Frame)

370/420/470/500/540/580/620

Cena: 4 212,- EUR 00.964.331.0

Adaptér s čepem ø 50 mm pro toto plato

Cena: 603,- EUR 02.481.374

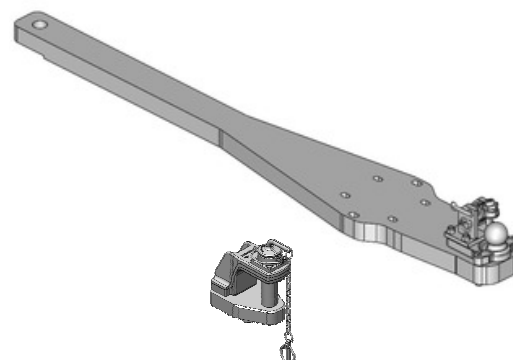

K-110 pro Steiger EP a Quadrac EP (Tier 4B)

370/420/470/500/540/580/620

Cena: 5 536,- EUR 00.962.331.0

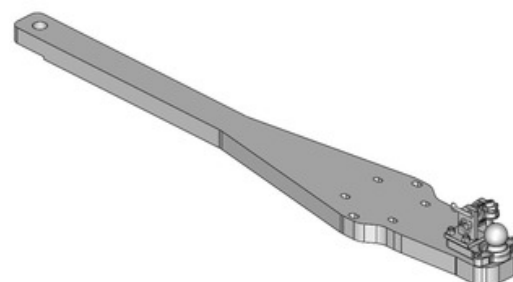

Case ostatní modely Spodní plata s koulí K-80 a K-110

**K-80 pro Steiger EP 350-600,
Quadrac EP Tier 4A 450-600,
STX 385/435/485/535**

Cena: 2 689,- EUR 00.964.329.0

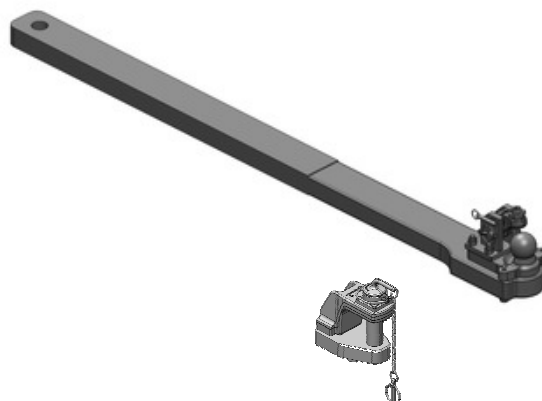

Adaptér s čepem ø 50 mm pro toto plato

Cena: 603,- EUR 02.481.374

Oboustranné nucené řízení s K-50 pro spodní plato s K-80

Cena: 940,- EUR 00.522.17.0

