

Challenger MT 525 – 545 AutoPower VI

**Konzola standardní s přípravou
na tažnou tyč nebo spodní plato, W335**

Cena: 1 676,- EUR 00.218.03.2

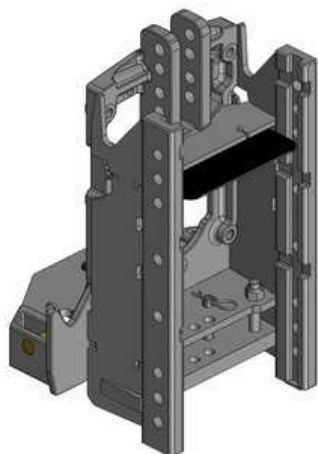

**Konzola krátká,
kompatibilní s hákem, W335**

Cena: 668,- EUR 00.218.10.1

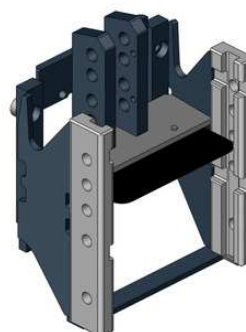

Konzola s koulí K-80, W335

Cena: 1 992,- EUR 00.218.81.0

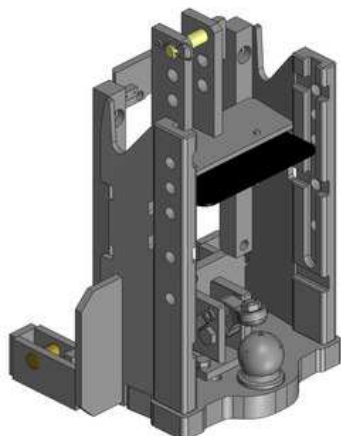

**Konzola s pitonfixem a s přípravou
na tažnou tyč nebo spodní plato, W335**

Cena: 2 252,- EUR 00.218.71.0

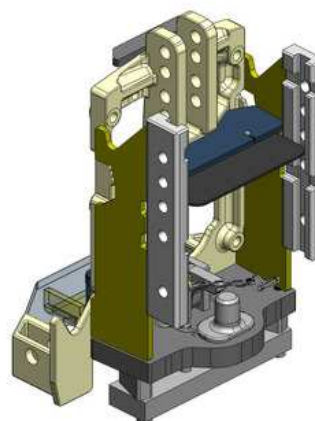

Spodní tažná tyč pro Scharmüller konzolu

Cena: 296,- EUR 10.820.605.0
10.820.745.0

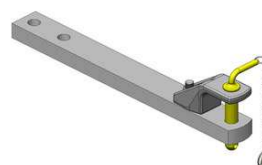

Challenger MT 525 – 545 AutoPower VI

**Spodní plato s koulí K-80
pro originální konzolu**

Cena: 1 304,- EUR 00.960.640.0

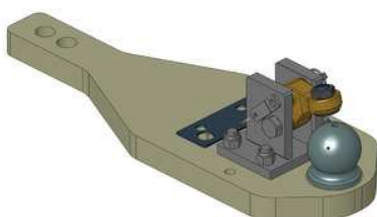

**Spodní plato s koulí K-80
pro originální konzolu, od v.č. V285019**

Cena: 1 304,- EUR 00.960.639.0

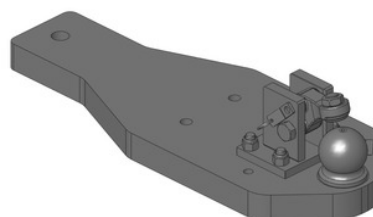

**Spodní plato s pitonfixem
pro originální konzolu**

Cena: 1 201,- EUR 00.961.640.0

00.961.639.0 (od v.č. V285019)

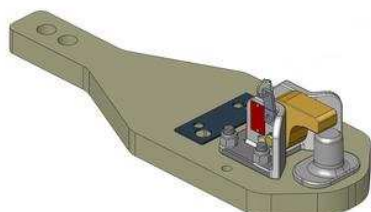

**Spodní plato s pitonfixem
pro originální konzolu, upravit**

Cena: 792,- EUR 00.961.041.0

848,- EUR 00.961.046.0 (od v.č. V285019)

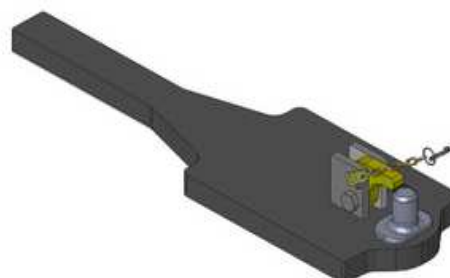

Oboustranné nucené řízení s K-50 pro spodní plato s K-80

Cena: 787,- EUR 00.521.0320.0

Nucení řízení jen pravé nebo levé

Cena: 489,- EUR

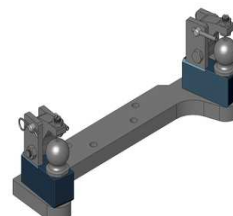

Challenger MT 525 – 545 AutoPower VI

Koule K-80 pro konzolu, dvoudílná

Cena: 920,- EUR 07.6335.42

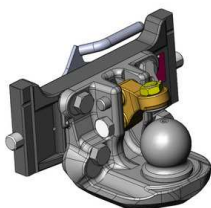

Koule K-80 pro konzolu, jednodílná, neautomatické zajištění, svislé zatížení 4 t

Cena: 740,- EUR 05.6335.51

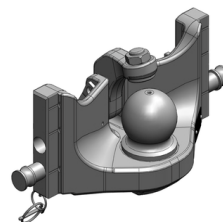

Pitonfix pro konzolu, dvoudílný

Cena: 730,- EUR 07.6335.32

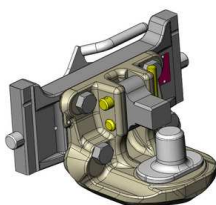

Pitonfix pro konzolu, jednodílný, neautomatické zajištění

Cena: 580,- EUR 05.6335.16

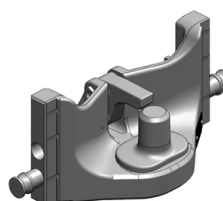

Koule K-50 pro konzolu

Cena: 640,- EUR 07.7335.03

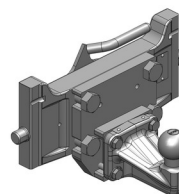

Hubice mechanická s kolíkem ø 30 nebo 38 mm

Cena: 543,- EUR
03.3355.06

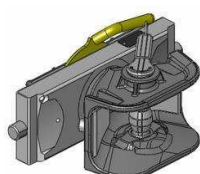

Hubice automatická s kolíkem ø 30 mm

Cena: 780,- EUR
03.3351.221

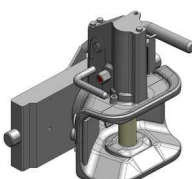

Hubice automatická s kolíkem ø 38 mm

Cena: 780,- EUR
11.3353.221

