

Claas Arion 410-460

**Konzola standardní, s přípravou
na tažnou tyč nebo spodní plato, W335**

Cena: 1 060,- EUR 00.218.05.2

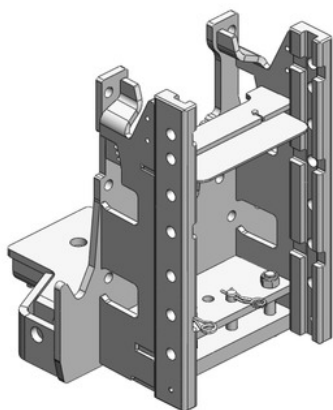

Konzola krátká, kompatibilní s hákem, W335

Cena: 668,- EUR 00.218.15.0

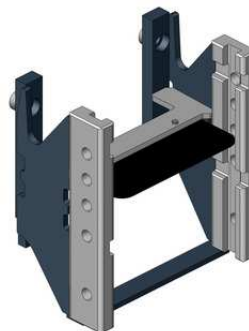

Tažná tyč

Cena: 296,- EUR 10.820.825.0

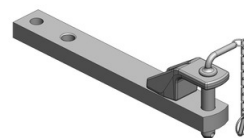

Spodní plato s koulí K-80

Cena: 1 274,- EUR 00.960.647.0

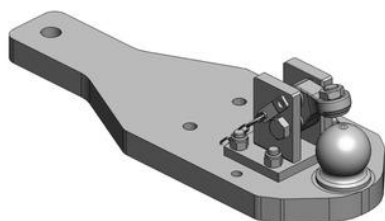

Spodní plato s koulí K-80, upravit

Cena: 818,- EUR 00.960.011.0

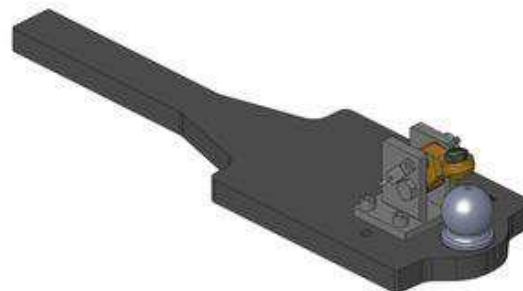

Spodní plato s pitonfixem, upravit

Cena: 792,- EUR 00.961.041.0

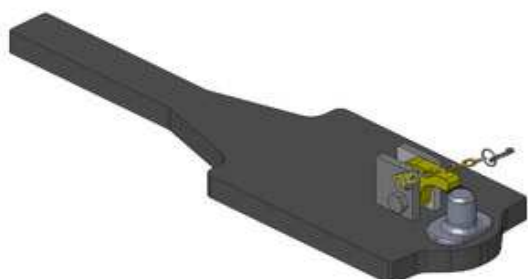

Spodní plato s pitonfixem

Cena: 1 019,- EUR 00.961.645.0

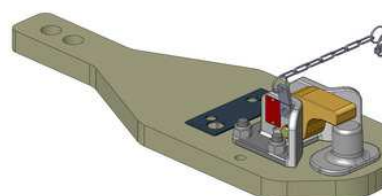

Claas Arion 410-460

Koule K-80 pro konzolu, dvoudílná

Cena: **920,- EUR** 07.6335.42

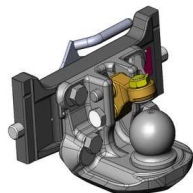

Koule K-80 pro konzolu, jednodílná, neautomatické zajištění, svislé zatížení 4 t

Cena: **740,- EUR** 05.6335.51

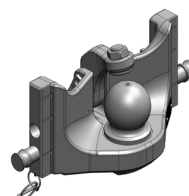

Pitonfix pro konzolu, dvoudílný

Cena: **730,- EUR** 07.6335.32

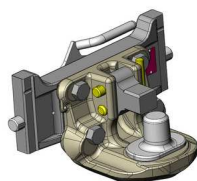

Pitonfix pro konzolu, jednodílný, neautomatické zajištění

Cena: **580,- EUR** 05.6335.16

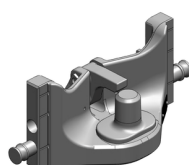

Koule K-50 pro konzolu

Cena: **640,- EUR** 07.7335.03

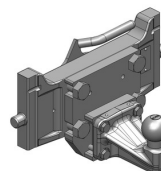

Hubice mechanická s kolíkem ø 30 nebo 38 mm

Cena: **543,- EUR**
03.3355.06

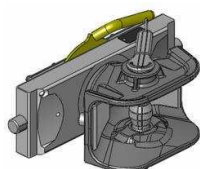

Hubice automatická s kolíkem ø 30 mm

Cena: **780,- EUR**
03.3351.221

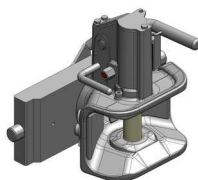

Hubice automatická s kolíkem ø 38 mm

Cena: **780,- EUR**
03.3353.221

