

Claas Axion 900 Terra Trac (od v.č. A42xxx)

Držák spodního plata

Cena: **791,- EUR** 00.226.50.1

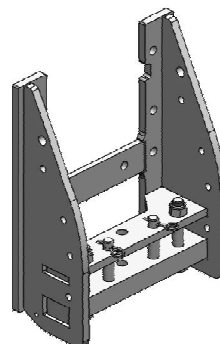

Spodní plato s K-80 (konzultace)

Cena: **1 764,- EUR** 00.960.444.0
00.960.444.2

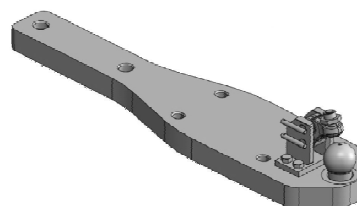

Nucené řízení s K-50 pro spodní plato s K-80

Levé: **489,- EUR** 00.520.57.0
Pravé: **489,- EUR** 00.520.56.0

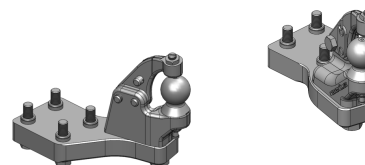

Tažná tyč

Cena: **1 214,- EUR** 10.820.925.1 (Cat. 3, \varnothing 38 mm)
1 957,- EUR 10.820.926.1 (Cat. 4, \varnothing 50 mm)
2 155,- EUR 10.820.927.1 (Cat. 4HD, \varnothing 50 mm)

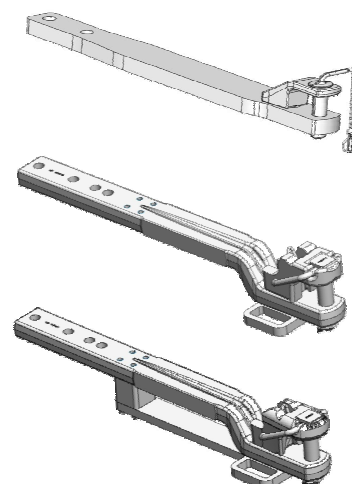

Konzola standardní, W390

Cena: **1 686,- EUR** 00.226.390.1

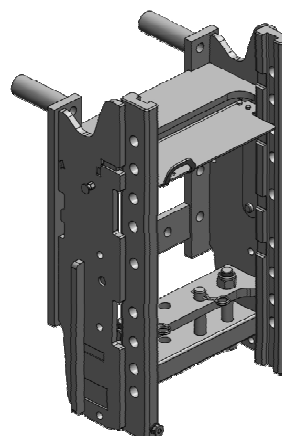

Claas Axion 900 Terra Trac (od v.č. A42xxx)

Koule K-80 do konzoly, jednodílná, svislé zatížení 4 t

Cena: 1 090,- EUR 05.6390.46-Š

Nucení řízení

Levé: 381,- EUR 00.520.65.0

Pravé: 381,- EUR 00.520.66.0



Koule K-80 do konzoly, jednodílná, vyosení 170 mm

Cena: 1 070,- EUR 05.6390.64-Š

(Lepší pro horní polohu při práci s homokinetickým kardanem.)

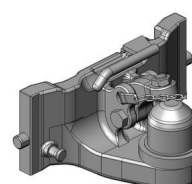

Koule K-80 do konzoly, dvoudílná

Cena: 970,- EUR 07.6390.42-Š

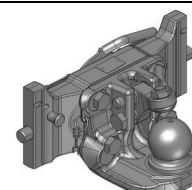

Nucené řízení pro dvoudílnou K-80

Cena: 976,- EUR 00.520.032.0

Nucené řízení jen pravé nebo levé

Cena: 725,- EUR

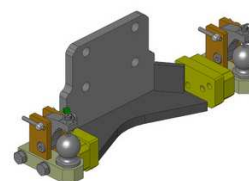

Pitonfix do konzoly, jednodílný, svislé zatížení 4 t

Cena: 890,- EUR 05.6390.16-Š

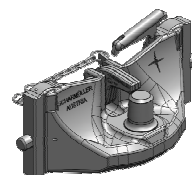

Pitonfix do konzoly, dvoudílný

Cena: 780,- EUR 07.6390.32-Š

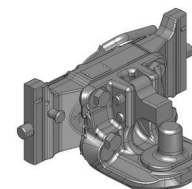

**Hubice mechanická
s kolíkem ø 30 nebo 38 mm**

Cena: 543,- EUR
07.3905.19-Š

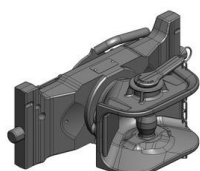

**Hubice automatická
s kolíkem ø 30 mm**

Cena: 890,- EUR
07.3901.291

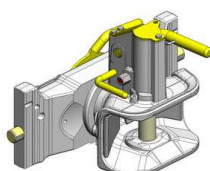

**Hubice automatická
s kolíkem ø 38 mm**

Cena: 890,- EUR
07.3903.292-Š

