

Fendt

Konzola s koulí K-80, W311 (pro Vario 200/300)

Cena: 1 583,- EUR 00.125.80.0

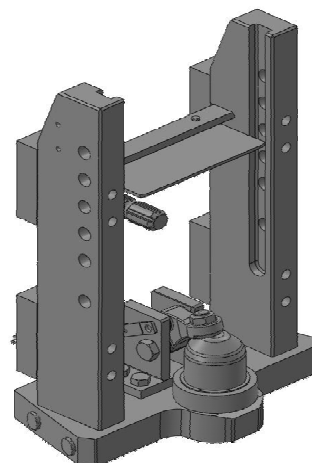

Spodní plato s koulí K-80 Fendt 200/300 Vario, od r. v. 2008

Cena: 1 229,- EUR 00.960.306.0

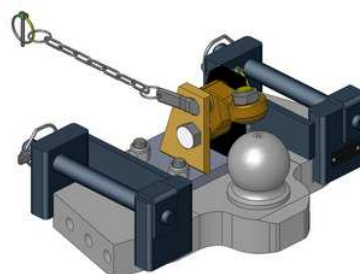

Spodní plato s koulí K-80 Fendt 800/900, do r. v. 12/2001

Cena: 1 233,- EUR 00.960.310.0

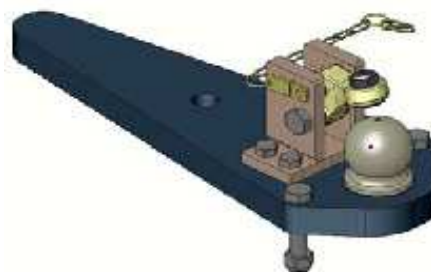

Spodní plato s koulí K-80 Fendt 300/500/GTA

Cena: 1 070,- EUR 00.960.3111.0

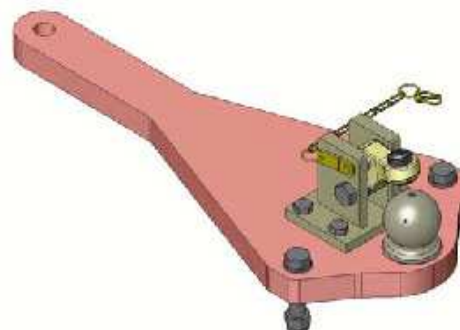

Spodní plato s koulí K-80 Fendt 400/700/800 Vario

Cena: 1 172,- EUR 00.960.3121.0

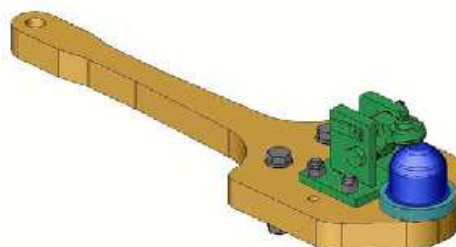

Fendt

Spodní plato s koulí K-80, jednoploché pro Fendt Favorit 800/900, od r. v. 2002

Cena: 1 040,- EUR 00.960.313.0

Scharmüller GmbH Hauptstr. 25 A - 4870 Vöcklamarkt	Typ/Ausf. 960313
M9675	
Kupplungskugel K80 mit Halterung	
Zul. D - Wert:	bis 89,3kN
Zul. Stützlast:	bis 3700kg
Zul. Zugösen	Typ 80 - XXXX
Verw. nur an Zgm nach §43(4) StVZO	

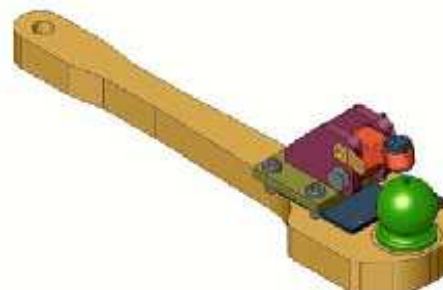

Spodní plato s koulí K-80, dvouploché pro Fendt Favorit 800/900, od r. v. 2002

Cena: 1 653,- EUR 00.960.3133.0

Scharmüller GmbH A-4870 Vöcklamarkt Hauptstr. 25	Typ / Ausf. 960313						
M9675							
Kupplungskugel 80 mit Halterung							
D - Wert	bis 89,3KN						
Zul. Stützlast	siehe Tabelle						
Zul. Zugöse	Typ 80- XXXX						
Verw. nur an Zgm nach §43 (4) StVZO							
<table border="1"> <tr> <td>A (mm)</td> <td>32</td> <td>195</td> </tr> <tr> <td>Stützlast (kg)</td> <td>3700</td> <td>2500</td> </tr> </table>		A (mm)	32	195	Stützlast (kg)	3700	2500
A (mm)	32	195					
Stützlast (kg)	3700	2500					

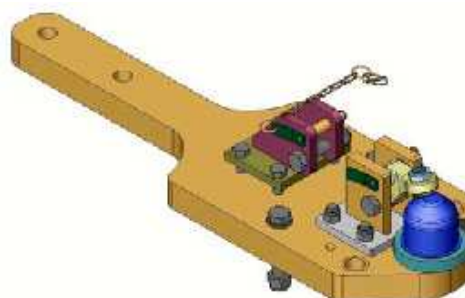

Oboustranné nucené řízení pro jednoploché plato 00.960.313.0 a pro dvouploché plato 00.960.3133.0, v zasunutém stavu

Cena: 787,- EUR 00.520.60.1

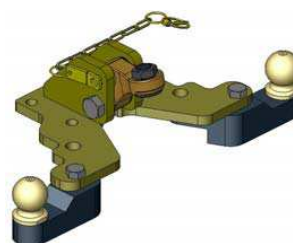

Oboustranné nucené řízení pro dvouploché plato 00.960.3133.0, ve vysunutém stavu a pro plato 00.960.3121.0 (pro Fendt 400/700/800 Vario)

Cena: 787,- EUR 00.521.0320.0

Nucené řízení jen pravé nebo levé

Cena: 489,- EUR

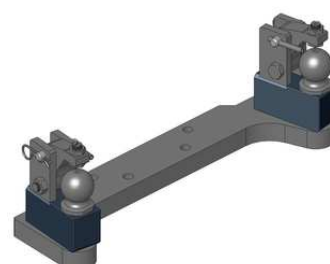

Fendt

**Spodní plato s koulí K-80
pro Fendt 400-1000 Vario, od r. v. 2008**

Cena: 1 450,- EUR 11.960.319.2

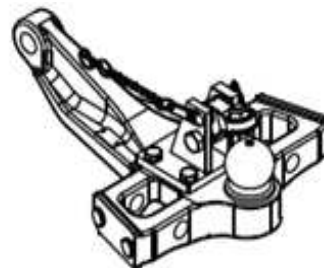

Výprodej

**Nucené řízení s K-50
pro Fendt Vario 200-300 a 400-900, od r. v. 2008 a 1038-1050**

Cena 1 ks: 417,- EUR 00.520.52.2



**Spodní plato s koulí K-80
pro Fendt 900 Vario MT 938-943**

Cena: 1 904,- EUR 00.960.571.0

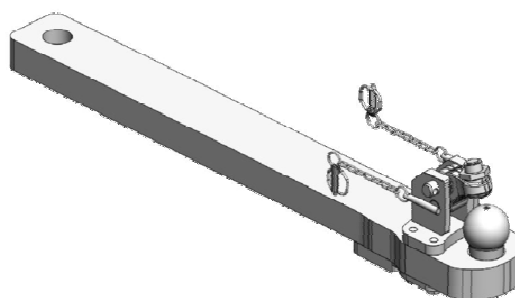

**Spodní plato s koulí K-80
pro Fendt 1100 Vario MT 1149-1165**

Cena: 2 917,- EUR 00.964.573.0



Fendt

Firmou Fendt jsou povoleny pouze tyto Scharmüller koule K-80:

**Fendt 200 Farmer/F/S/SA/V/P
W241**

Cena: 920,- EUR
03.6241.32



**Fendt 200/300/400/500/700/800 Vario
W311**

Cena: 920,- EUR
05.6311.420

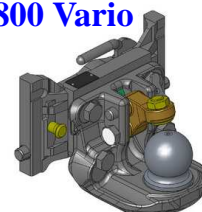

**Fendt Favorit 800/900
W330**

Cena: 920,- EUR
07.6330.42

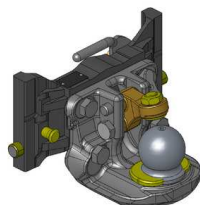

**Fendt Vario 819-828 a 939
Fendt Vario 714-724 a 924-936 a 1038-1050
(od podzimu 2011), W390**

Cena: 970,- EUR
07.6390.42-Š



**Fendt Vario 819-828 a 939
Fendt Vario 714-724 a 924-936 a 1038-1050
(od podzimu 2011), jednodílná, 4 t
W390**

Cena: 1 090,- EUR
05.6390.46-Š

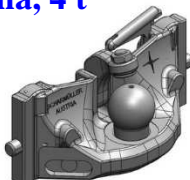

**Fendt Vario 819-828 a 939
Fendt Vario 714-724 a 924-936 a 1038-1050
(od podzimu 2011), jednodílná,
vyosení 170 mm, W390**

Cena: 1 070,- EUR
05.6390.64

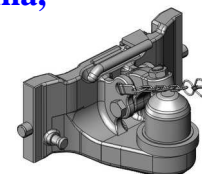

**Koule K-80 jednodílná,
neautomatické zajištění, svislé zatížení 4 t
Fendt 200/300/400/500/700/800 Vario
W311**

Cena: 840,- EUR
05.6311.51

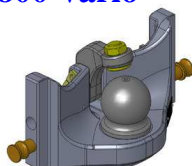

**Koule K-80 jednodílná,
neautomatické zajištění, svislé zatížení 4 t
W330**

Cena: 740,- EUR
05.6330.51

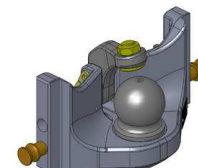

**Pitonfix jednodílný, neautomatické zajištění
Fendt 200/300/400/500/700/800 Vario
W311**

Cena: 580,- EUR
05.6311.16

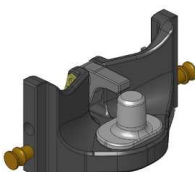

**Pitonfix dvoudílný
Fendt Vario 819-828 a 939
Fendt Vario 714-724 a 924-936
(od podzimu 2011) a 1038-1050, W390**

Cena: 780,- EUR
07.6390.32-Š

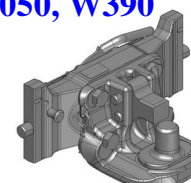

POZOR: Koule K-80 do konzoly nejsou Fendtem povoleny pro provoz v oblasti pod kardanem při současném napojení kardanu. K tomu jsou určena spodní plata s K-80, která mají odpovídající nosnost.

Fendt

Koule K-50 pro konzolu

Fendt 200 Farmer, 200 SA, 200 V/F/P Vario (vyosení 180 mm)

Fendt 200/300/400/500/700/800 Vario

Fendt 800-900 Favorit / 900 Vario

W241: 640,- EUR 03.6241.03

W311: 640,- EUR 05.7311.03

W330: 640,- EUR 05.7330.03

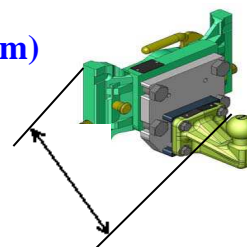

vyosení 190 mm

Hubice pro konzolu

Fendt 200 Farmer, 200 SA, 200 V/F/P Vario

Fendt 200/300/400/500/700/800 Vario

Fendt Favorit 800/900 Vario

Fendt Vario 819-828 a 939

Fendt Vario 714-724 a 924-939 (od podzimu 2011) a 1038-1050

W241

W311

W330

W390

W390

Mechanická s kolíkem ø 30 nebo 38 mm

W241: 470,- EUR 03.2415.01

W311: 543,- EUR 05.3115.06

W330: 543,- EUR 03.3305.06

W390: 543,- EUR 07.3905.19-Š

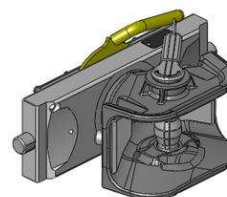

Automatická s kolíkem ø 30 mm

W241: 901,- EUR 03.2411.221

W311: 840,- EUR 05.3111.221

W330: 780,- EUR 03.3301.021

W390: 890,- EUR 07.3901.192

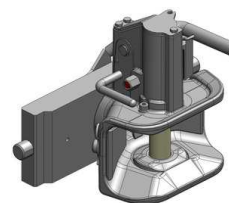

Automatická s kolíkem ø 38 mm

W241: 901,- EUR 03.2413.221

W311: 840,- EUR 05.3113.221

W330: 780,- EUR 03.3303.221

W390: 890,- EUR 07.3903.292-Š

