

Kubota M 6.101-141 Utility

Konzola s přípravou na tažnou tyč

Cena: 991,- EUR 00.258.05.0

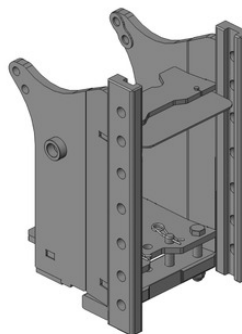

Konzola krátká

Cena: 748,- EUR 00.258.12.0

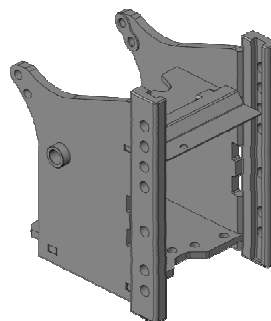

Tažná tyč

Cena: 296,- EUR 10.820.740.1

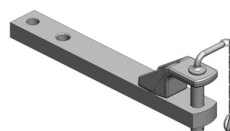

Spodní plato s K-80, upravit

Cena: 818,- EUR 00.960.011.0

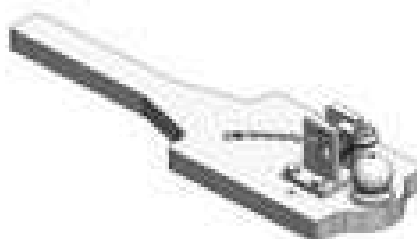

Spodní plato s pitonfixem, upravit

Cena: 464,- EUR 00.961.031.0

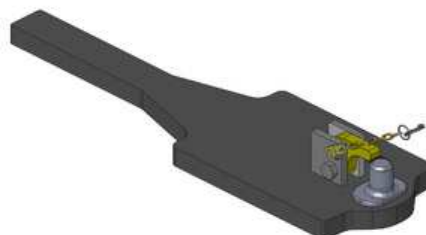

Kubota M 6.101-141 Utility

Koule K-80 pro konzolu, dvoudílná

Cena: **920,- EUR** 07.6330.42

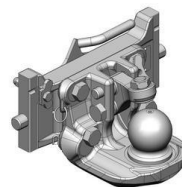

Pitonfix pro konzolu, dvoudílný

Cena: **730,- EUR** 07.6330.32

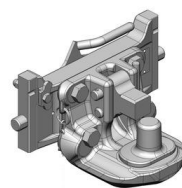

Koule K-80 pro konzolu, jednodílná, neautomatické zajištění, svislé zatížení 4 t

Cena: **740,- EUR** 05.6330.51

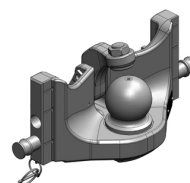

Pitonfix pro konzolu, jednodílný, neautomatické zajištění

Cena: **580,- EUR** 05.6330.16

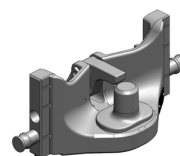

Koule K-50 pro konzolu

Cena: **640,- EUR** 07.7330.04

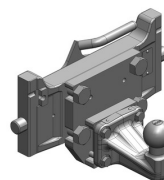

Hubice mechanická s kolíkem ø 30 nebo 38 mm

Cena: **470,- EUR**
03.3304.940

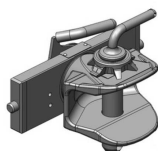

Hubice automatická s kolíkem ø 30

Cena: **780,- EUR**
03.3301.221

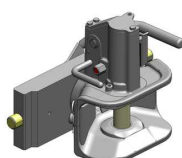

Hubice automatická s kolíkem ø 38 mm

Cena: **780,- EUR**
03.3303.221

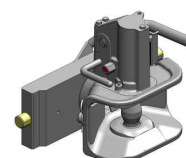

Kubota M 6.101-141 Utility

Hydraulický hák vč. tažné tyče

Cena: 4 702,- EUR 00.400.67.1

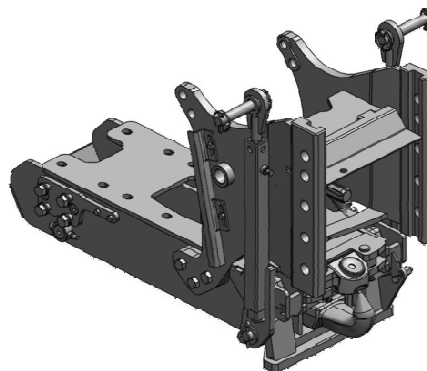

Vložka K-80 do háku

Cena: 779,- EUR 00.427.11.0

