

Kubota M 6.121-6.142

Konzola standardní, W330

Cena: 826,- EUR 00.258.30.0

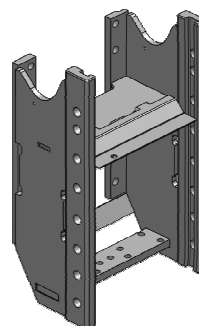

Tažná tyč do konzoly krátká, zatížení 1600 kg

Cena: 653,- EUR 00.833.00.0

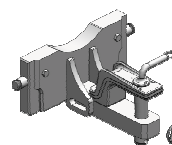

Tažná tyč, sada vč. držáků

Cena: 650,- EUR 00.807.07.0

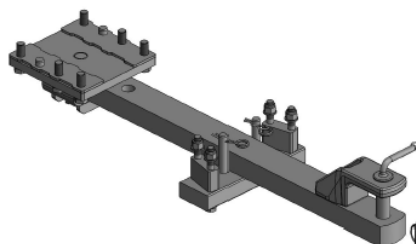

Spodní plato s K-80, vč. držáků

Cena: 1 937,- EUR 00.960.604.0-SET

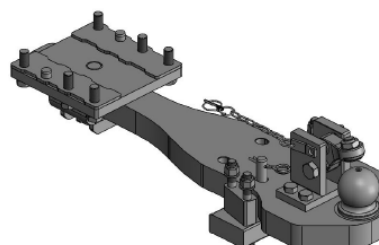

Spodní plato s pitonfixem

Cena: 1 301,- EUR 00.961.604.0

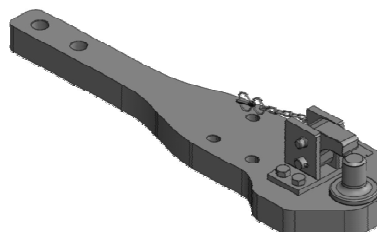

Spodní plato s pitonfixem, upravit

Cena: 848,- EUR 00.961.046.0



Kubota M 6.121-6.142

Koule K-80 pro konzolu, dvoudílná

Cena: **920,- EUR** 07.6330.42

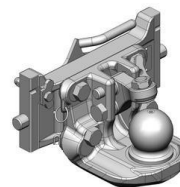

Pitonfix pro konzolu, dvoudílný

Cena: **730,- EUR** 07.6330.32

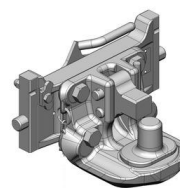

Koule K-80 pro konzolu, jednodílná, neautomatické zajištění, svislé zatížení 4 t

Cena: **740,- EUR** 05.6330.51

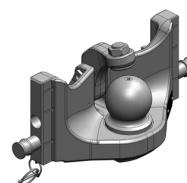

Pitonfix pro konzolu, jednodílný, neautomatické zajištění

Cena: **580,- EUR** 05.6330.16

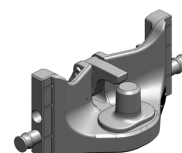

Koule K-50 pro konzolu

Cena: **640,- EUR** 07.7330.05

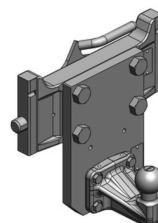

Hubice mechanická s kolíkem ø 30 nebo 38 mm

Cena: **543,- EUR**
03.3305.06

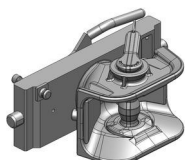

Hubice automatická s kolíkem ø 30

Cena: **780,- EUR**
03.3301.221

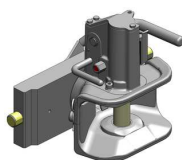

Hubice automatická s kolíkem ø 38 mm

Cena: **780,- EUR**
03.3303.221

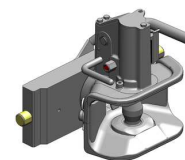

Kubota M 6.121-6.142

Hák hydraulický vč. tažné tyče

Cena: 4 949,- EUR 00.400.54.0

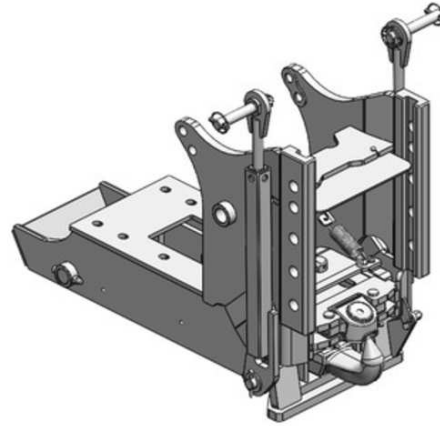

Vložka K-80 do háku

Cena: 779,- EUR 00.427.11.0

