

## Kubota M 8540-9540-8560-9960

### Konzola s přípravou na tažnou tyč

**Cena: 927,- EUR** 00.258.02.2

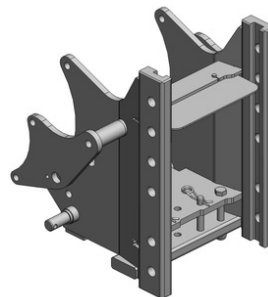

### Tažná tyč

**Cena: 296,- EUR** 10.820.605.0

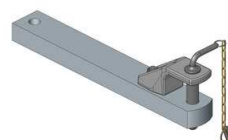

### Spodní plato s K-80

**Cena: 1 037,- EUR** 00.960.012.0

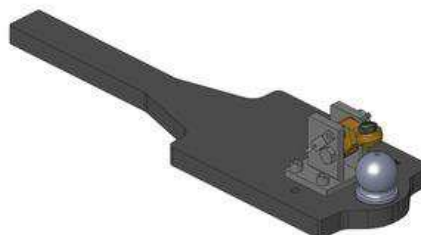

### Spodní plato s pitonfixem, upravit

**Cena: 848,- EUR** 00.961.046.0

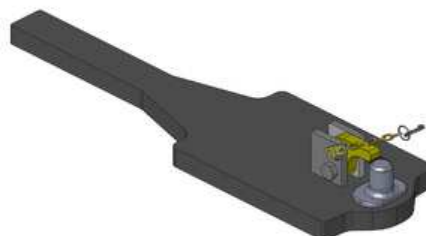

### Hák hydraulický vč. tažné tyče a vč. zkrácené konzoly pro horní závěs

**Cena: 4 140,- EUR** 00.400.66.0

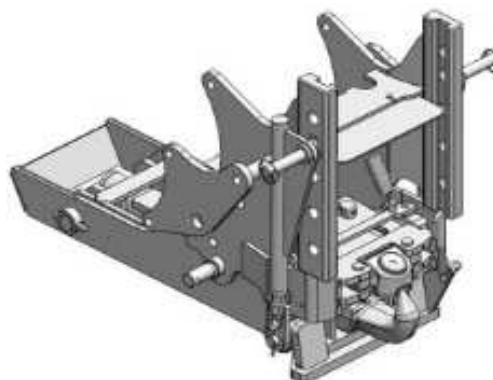

### Vložka K-80 do háku

**Cena: 779,- EUR** 00.427.11.0



## Kubota M 8540-9540-8560-9960

### Koule K-80 pro konzolu, dvoudílná

Cena: **920,- EUR** 07.6330.42

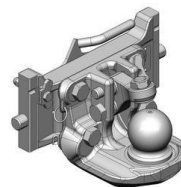

### Pitonfix pro konzolu, dvoudílný

Cena: **730,- EUR** 07.6330.32

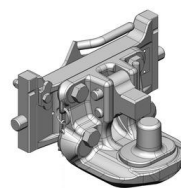

### Koule K-80 pro konzolu, jednodílná, neautomatické zajištění, svislé zatížení 4 t

Cena: **740,- EUR** 05.6330.51

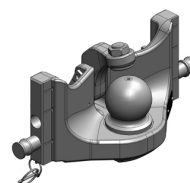

### Pitonfix pro konzolu, jednodílný, neautomatické zajištění

Cena: **580,- EUR** 05.6330.16

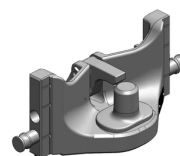

### Koule K-50 pro konzolu

Cena: **640,- EUR** 07.7330.04

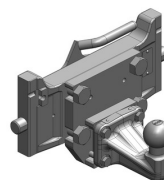

### Hubice mechanická s kolíkem ø 30 nebo 38 mm

Cena: **470,- EUR**  
03.3304.940

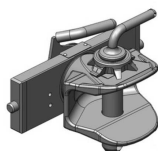

### Hubice automatická s kolíkem ø 30

Cena: **780,- EUR**  
03.3301.221

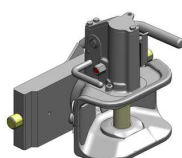

### Hubice automatická s kolíkem ø 38 mm

Cena: **780,- EUR**  
03.3303.221

