

New Holland TSA, T6000, T6.120-6.180 vč. Auto Command, T7.170-7.210

Konzola standardní (8 poloh), W330

Cena: 1 011,- EUR 00.116.08.1

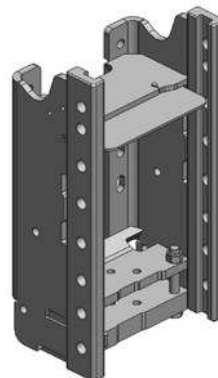

Konzola kompatibilní s hákem CNH i Scharmüller (6 poloh), W330

Cena: 668,- EUR 00.111.11.0

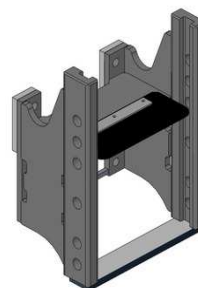

Konzola s pitonfixem, W330

Cena: 1 479,- EUR 00.116.71.2



Konzola s koulí K-80

W330: 1 824,- EUR 00.116.81.2

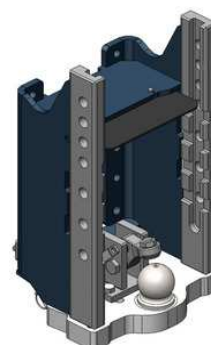

New Holland TSA, T6000, T6.120-6.180 vč. Auto Command, T7.170-7.210

Spodní plato s koulí K-80, pro originální konzolu CNH

Cena: 1 345,- EUR 00.960.593.2

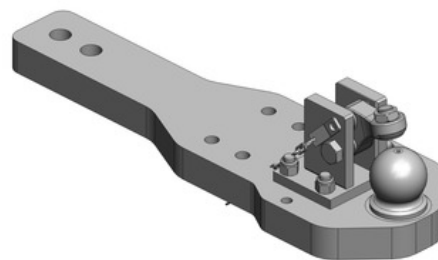

(ne pro T7.xxx)

Spodní plato s koulí K-80, pro originální konzolu CNH

Cena: 1 545,- EUR 00.960.594.1-SET1

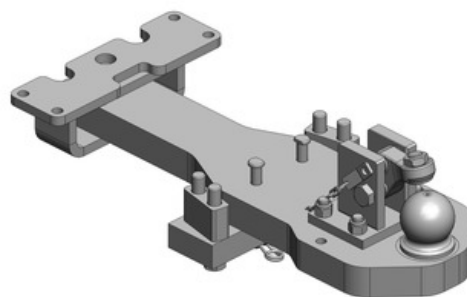

(vč. držáků uvedených na obrázku)
(pro modely T6.120-6.175 s AdBlue)
(NE pro modely T6.125-6.180 Tier 4b)

Spodní plato s koulí K-80, pro originální konzolu CNH

Cena: 1 545,- EUR 00.960.594.1-SET2

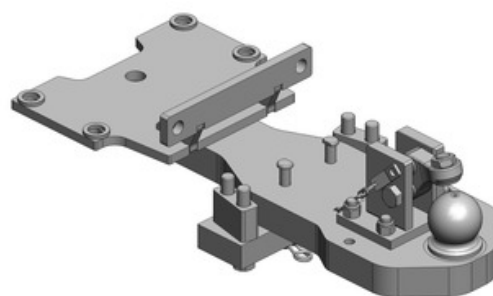

(vč. držáků uvedených na obrázku)
(pro modely T6030-6090 Range a Power Command, T7.170-7.210 s AdBlue)

Spodní plato s koulí K-80, pro originální konzolu CNH (i tu s pitonfixem)

Cena: 1 487,- EUR 00.960.597.3

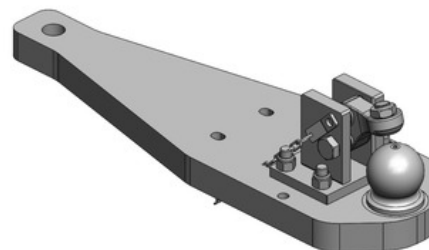

(pro modely T6030-6090 Range a Power Command, T7.170-7.210 s AdBlue)

New Holland TSA, T6000, T6.120-6.180 vč. Auto Command, T7.170-7.210

Spodní plato s koulí K-80, upravit

Cena: **818,- EUR – 40 mm** 00.960.011.0
 867,- EUR – 45 mm 00.960.010.0

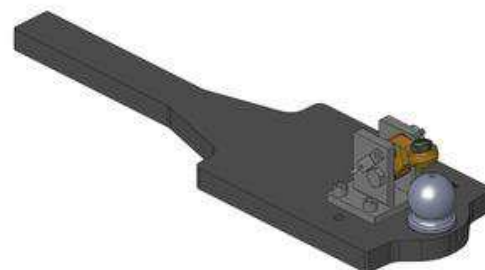

Spodní plato s pitonfixem, upravit

Cena: **792,- EUR – 40 mm** 00.961.041.0
 825,- EUR – 45 mm 00.961.043.0

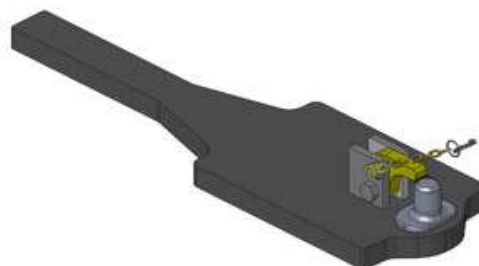

Tažná tyč

Cena: **608,- EUR** 00.807.45.0
 551,- EUR 00.807.47.0

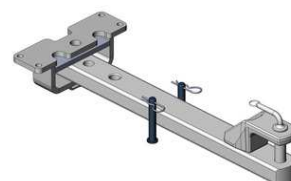

Oboustranné nucené řízení s K-50 pro spodní plato s K-80

Cena: **787,- EUR** 00.521.0320.0

Nucené řízení jen pravé nebo levé

Cena: **489,- EUR**

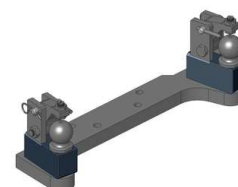

New Holland TSA, T6000, T6.120-6.180 vč. Auto Command, T7.170-7.210

Koule K-80 pro konzolu

originál CNH:	990,- EUR	03.6320.46
W330:	920,- EUR	07.6330.42

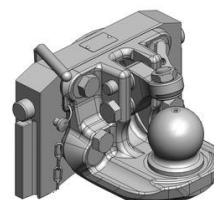

Pitonfix pro konzolu

originál CNH:	800,- EUR	03.6320.25
W330:	730,- EUR	07.6330.32

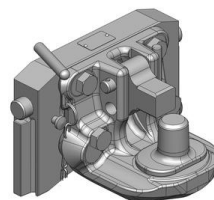

Koule K-80 pro standardní konzolu W330, neautomatické zajištění, svislé zatížení 4 t

Cena:	740,- EUR	05.6330.51
-------	-----------	------------

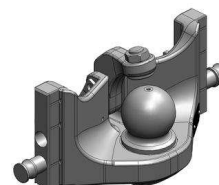

Pitonfix pro standardní konzolu W330, neautomatické zajištění

Cena:	580,- EUR	05.6330.16
-------	-----------	------------

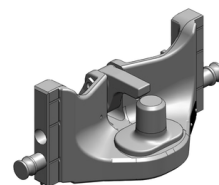

Koule K-50 pro konzolu

originál CNH:	640,- EUR	03.7320.04
W330:	640,- EUR	07.7330.04

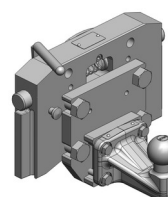

New Holland TSA, T6000, T6.120-6.180 vč. Auto Command, T7.170-7.210

Hubice mechanická s kolíkem ø 30 nebo 38 mm pro konzolu

originál CNH:	543,- EUR	03.3205.06
W330:	543,- EUR	03.3305.06
W325:	543,- EUR	05.3255.06

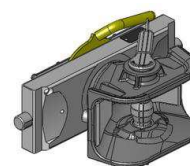

Hubice automatická s kolíkem ø 30 mm pro konzolu

originál CNH:	880,- EUR	03.6320.431
W330:	780,- EUR	03.3301.021
W325:	840,- EUR	05.3251.321

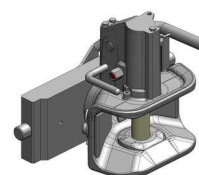

Hubice automatická s kolíkem ø 38 mm pro konzolu

originál CNH:	880,- EUR	03.6320.531
W330:	780,- EUR	03.3303.221
W325:	840,- EUR	05.3253.321

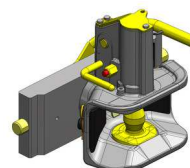

New Holland TSA, T6000, T6.120-6.180 vč. Auto Command, T7.170-7.210

Hydraulický hák vč. tažné tyče

Cena: 3 778,- EUR 00.400.70.2

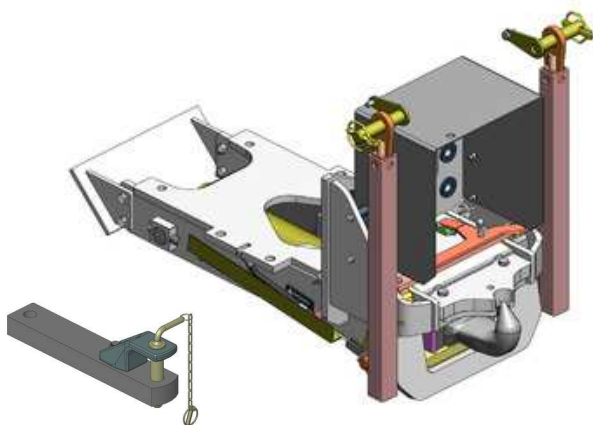

(pouze pro TSA, T6000 Delta, Elite, Plus
T6.120-6.180 vč. Auto Command)

Hydraulický hák vč. tažné tyče a vč. zkrácené konzoly pro horní závěs (W330)

Cena: 5 143,- EUR 00.400.83.0

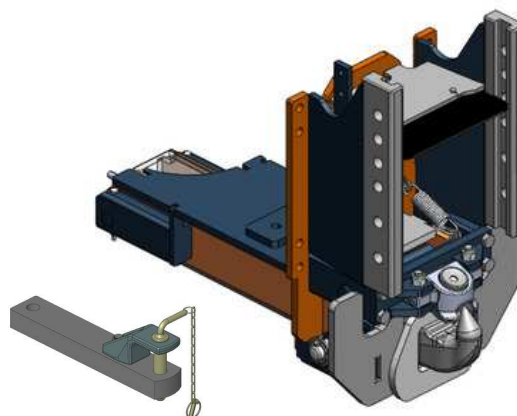

(pouze pro T6000 Range/Power Command, T7.170-7.210)

Vložka K-80 do háku 00.400.70.2, zatížení 3 t

Cena: 1 600,- EUR 00.423.00.0

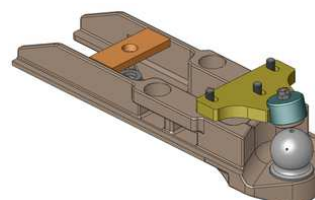

**Vložka K-80 do háku 00.400.70.2, zatížení 2 t,
možnost připojení nuceného řízení**

Cena: 981,- EUR 00.427.01.0

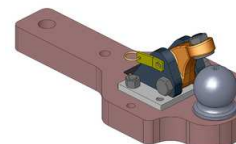

Vložka K-80 do háku 00.400.83.0, svislé zatížení 4 t

Cena: 840,- EUR 10.866.500.0

