

## New Holland TVT a T7500

### Konzola standardní, 8 poloh

Cena: **854,- EUR** 00.110.05.0

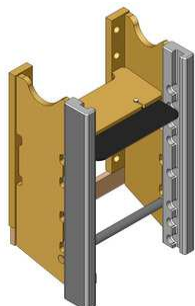

### Konzola standardní, 9 poloh

Cena: **1 089,- EUR** 00.110.05.2

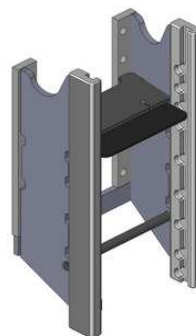

### Konzola krátká kompatibilní s hákem, 5 poloh

Cena: **668,- EUR** 00.110.15.0

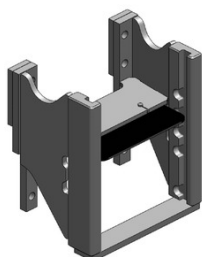

### Konzola s přípravou pro tažnou tyč nebo spodní plato

Cena: **981,- EUR** 00.110.55.0

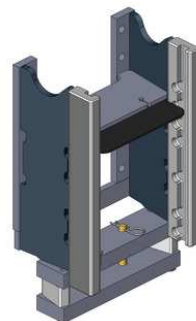

### Konzola s pitonfixem a přípravou pro tažnou tyč nebo spodní plato

Cena: **1 292,- EUR** 00.110.75.0

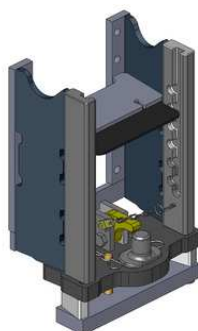

### Tažná tyč standard

Cena: **507,- EUR** 00.807.01.0



## New Holland TVT a T7500

### Konzola s koulí K-80 standard W325

8 poloh: 1 583,- EUR 00.110.84.2  
9 poloh: 1 756,- EUR 00.110.87.0

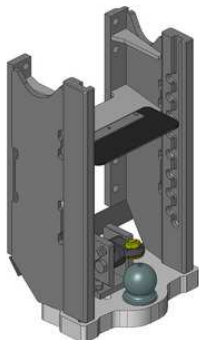

### Konzola s koulí K-80, W330

Cena: 1 583,- EUR 00.110.84.4

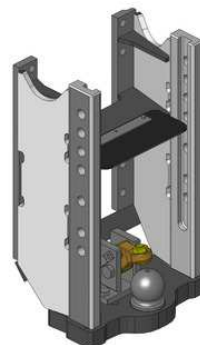

### Konzola s koulí K-80, W325, automatické zajištění K-80

Cena: 1 756,- EUR 00.110.88.0

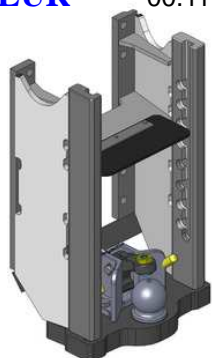

### Tažná tyč pro konzolu s K-80

Cena: 663,- EUR 00.807.10.0

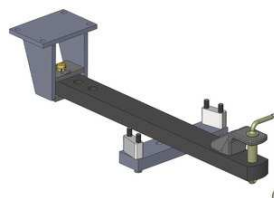

### Spodní plato s koulí K-80, 3-polohové

Cena: 1 588,- EUR 00.960.290.3

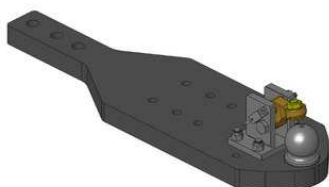

### Spodní plato s pitonfixem (upravit)

Cena: 848,- EUR 00.961.046.0

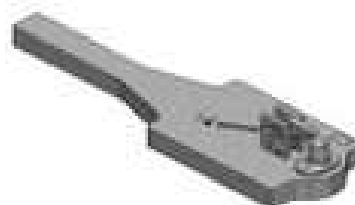

### Oboustranné nucené řízení s K-50 pro spodní plato s K-80

Cena: 787,- EUR 00.521.0320.0

### Nucené řízení jen pravé nebo levé

Cena: 489,- EUR

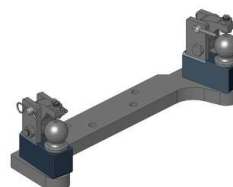

## New Holland TVT a T7500

**Hák hydraulický vč. koncovky tažné tyče**

**Cena: 3 570,- EUR**      00.400.52.3

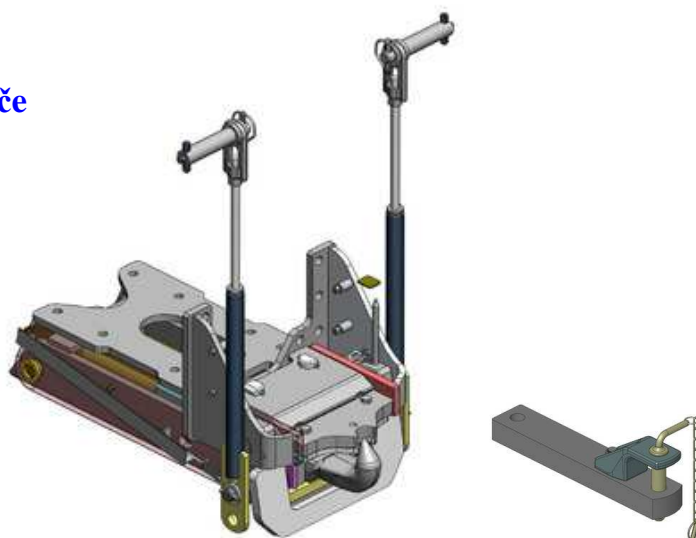

**Vložka K-80 do háku, zatížení 3 t**

**Cena: 1 444,- EUR**      00.423.00.0

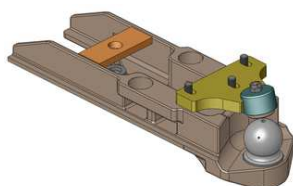

**Vložka K-80 do háku, zatížení 2 t,  
možnost připojení nuceného řízení**

**Cena: 981,- EUR**      00.427.01.0

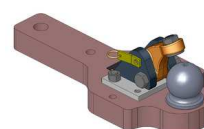

**Koule K-80 do konzoly, 2 polohová**

**Cena: 970,- EUR**      05.6325.33

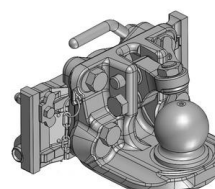

**Pitonfix do konzoly**

**Cena: 865,- EUR**      05.6325.10

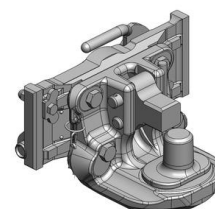

**Mechanická hubice  
s kolíkem ø 30 nebo 38 mm**

**Cena: 470,- EUR**  
05.3255.01

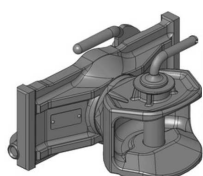

**Hubice automatická  
s kolíkem ø 30 mm**

**AKCE: 400,- EUR**  
05.3251.32

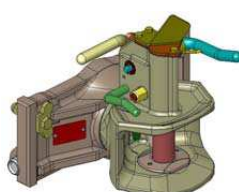

**Hubice automatická  
s kolíkem ø 38 mm**

**Cena: 840,- EUR**  
05.3253.321

