

Valtra série N, T, C, M, XM, 6000, 8000

**Konzola standardní,
8 poloh**

Cena: 668,- EUR 00.146.01.2

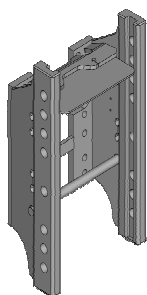

**Konzola vysoká
zesílená, 9 poloh**

Cena: 1 376,- EUR 00.146.21.2

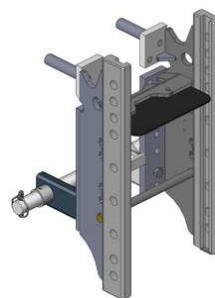

**Konzola krátká
kompatibilní s hákem, 5 poloh**

Cena: 668,- EUR 00.146.12.0

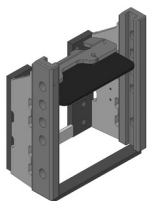

**Konzola s přípravou na spodní plato
nebo tažnou tyč, vysoká, zesílená,
4 t s platem K-80**

Cena: 1 866,- EUR 00.146.56.0

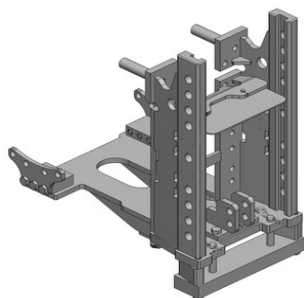

Tažná tyč

Cena: 296,- EUR 10.820.605.0

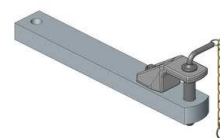

Valtra série N, T, C, M, XM, 6000, 8000

Konzola s pitonfixem

Cena: **1 292,- EUR** 00.146.61.0

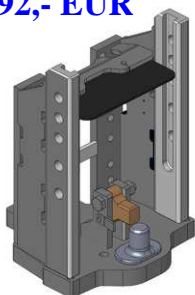

Konzola s pitonfixem vč. tažné tyče

Cena: **1 446,- EUR** 00.146.72.0

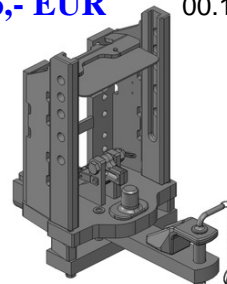

Konzola s koulí K-80

Cena: **1 583,- EUR** 00.146.81.0

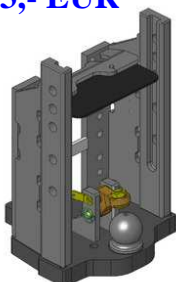

Konzola s koulí K-80 vč. tažné tyče

Cena: **1 994,- EUR** 00.146.92.1

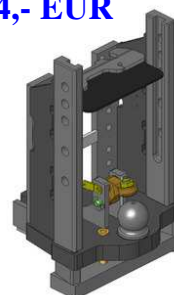

Spodní plato s koulí K-80

Cena: **1 092,- EUR** 00.960.366.0

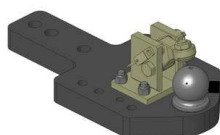

Spodní plato s koulí K-80, 4 t, pro konzolu 00.146.56.0

Cena: **1 092,- EUR** 00.960.368.0

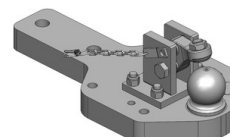

Spodní plato s pitonfixem pro konzolu 00.146.56.0

Cena: **836,- EUR** 00.961.368.0

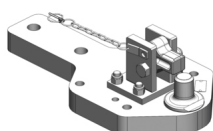

Oboustranné nucené řízení s K-50 pro spodní plato s K-80

Cena: **787,- EUR** 00.521.0320.0

Nucené řízení jen pravé nebo levé

Cena: **489,- EUR**

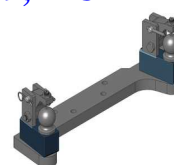

Valtra série N, T, C, M, XM, 6000, 8000

Koule K-80 dvoudílná

do r. 2001: **970,- EUR** 05.6325.33

od r. 2002: **920,- EUR** 07.6330.42

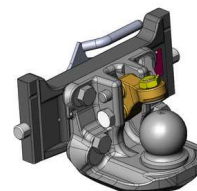

Pitonfix dvoudílný

do r. 2001: **865,- EUR** 05.6325.10

od r. 2002: **730,- EUR** 07.6330.32

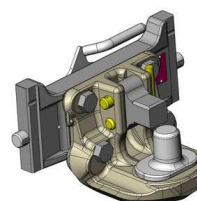

**Koule K-80 pro konzolu, jednodílná,
neautomatické zajištění, svislé zatížení 4 t**
od r. 2002: **740,- EUR** 05.6330.51

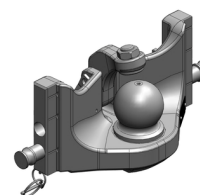

**Pitonfix pro konzolu, jednodílný,
neautomatické zajištění**
od r. 2002: **580,- EUR** 05.6330.16

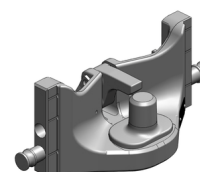

Koule K-50 pro konzolu

do r. 2001: **640,- EUR** 05.7325.03

od r. 2002: **640,- EUR** 07.7330.04

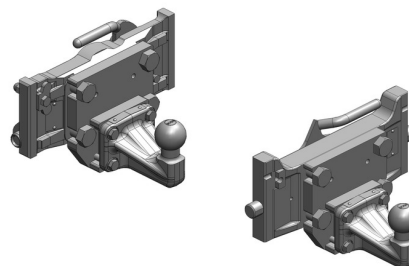

**Hubice mechanická
s kolíkem ø 30 nebo 38 mm**

do r. 2001: **400,- EUR**
05.3255.88

od r. 2002: **543,- EUR**
03.3305.06

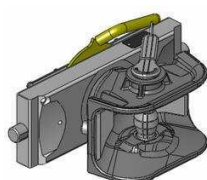

**Hubice automatická
s kolíkem ø 30 mm**

do r. 2001: **400,- EUR**
AKCE: 05.3251.32

od r. 2002: **780,- EUR**
03.3301.021

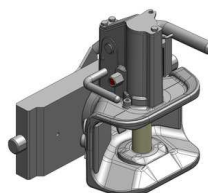

**Hubice automatická
s kolíkem ø 38 mm**

do r. 2001: **840,- EUR**
05.3253.321

od r. 2002: **780,- EUR**
03.3303.221

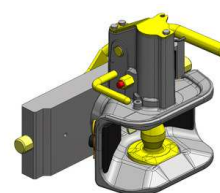

Valtra série N, T, C, M, XM, 6000, 8000

Hák hydraulický vč. tažné tyče

Cena: 3 804,- EUR 00.419.50.5

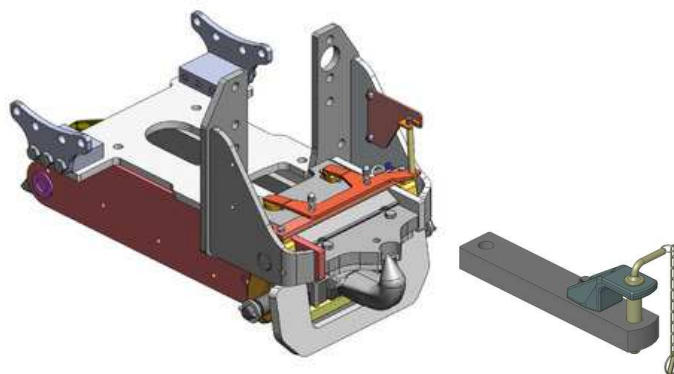

Vložka K-80 do háku, zatížení 3 t

Cena: 1 600,- EUR 00.423.00.0

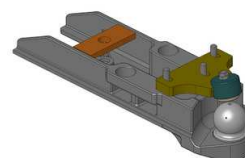

**Vložka K-80 do háku, zatížení 2 t,
možnost připojení nuceného řízení**

Cena: 981,- EUR 00.427.01.0

