

## Valtra série N, T, C, M, XM, 6000, 8000

**Konzola standardní,  
8 poloh**

**Cena: 668,- EUR** 00.146.01.2

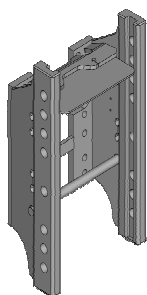

**Konzola vysoká  
zesílená, 9 poloh**

**Cena: 1 376,- EUR** 00.146.21.2

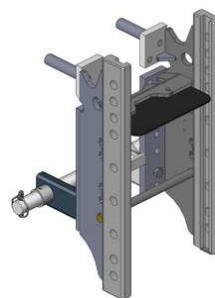

**Konzola krátká  
kompatibilní s hákem, 5 poloh**

**Cena: 668,- EUR** 00.146.12.0

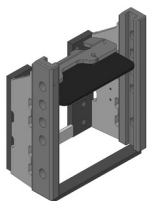

**Konzola s přípravou na spodní plato  
nebo tažnou tyč, vysoká, zesílená,  
4 t s platem K-80**

**Cena: 1 866,- EUR** 00.146.56.0

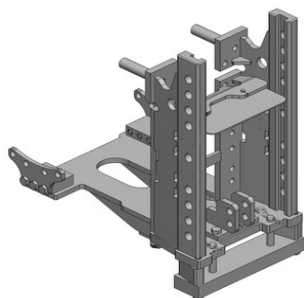

**Tažná tyč**

**Cena: 296,- EUR** 10.820.605.0

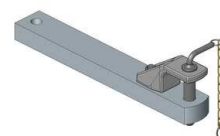

## Valtra série N, T, C, M, XM, 6000, 8000

### Konzola s pitonfixem

Cena: **1 292,- EUR** 00.146.61.0

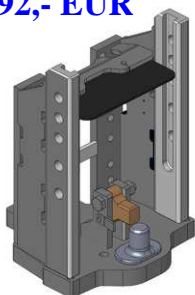

### Konzola s pitonfixem vč. tažné tyče

Cena: **1 446,- EUR** 00.146.72.0

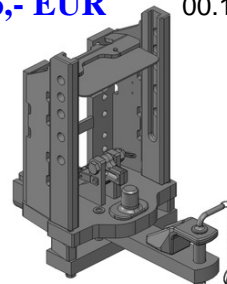

### Konzola s koulí K-80

Cena: **1 583,- EUR** 00.146.81.0

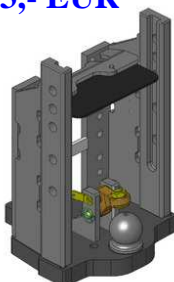

### Konzola s koulí K-80 vč. tažné tyče

Cena: **1 994,- EUR** 00.146.92.1

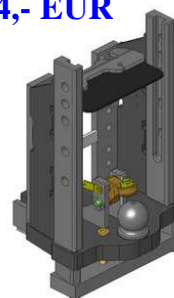

### Spodní plato s koulí K-80

Cena: **1 092,- EUR** 00.960.366.0

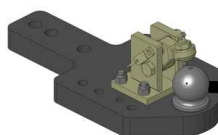

### Spodní plato s koulí K-80, 4 t, pro konzolu 00.146.56.0

Cena: **1 092,- EUR** 00.960.368.0

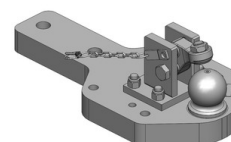

### Oboustranné nucené řízení s K-50 pro spodní plato s K-80

Cena: **787,- EUR** 00.521.0320.0

### Nucené řízení jen pravé nebo levé

Cena: **489,- EUR**

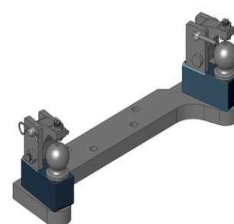

## Valtra série N, T, C, M, XM, 6000, 8000

### Koule K-80 dvoudílná

do r. 2001: **970,- EUR** 05.6325.33

od r. 2002: **920,- EUR** 07.6330.42

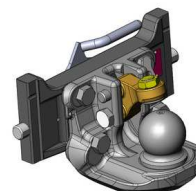

### Pitonfix dvoudílný

do r. 2001: **865,- EUR** 05.6325.10

od r. 2002: **730,- EUR** 07.6330.32

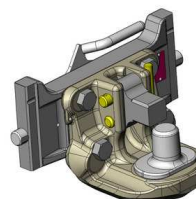

**Koule K-80 pro konzolu, jednodílná,  
neautomatické zajištění, svislé zatížení 4 t**  
od r. 2002: **740,- EUR** 05.6330.51

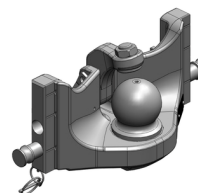

**Pitonfix pro konzolu, jednodílný,  
neautomatické zajištění**  
od r. 2002: **580,- EUR** 05.6330.16

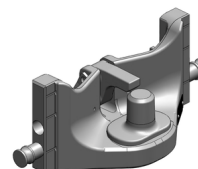

### Koule K-50 pro konzolu

do r. 2001: **640,- EUR** 05.7325.03

od r. 2002: **640,- EUR** 07.7330.04

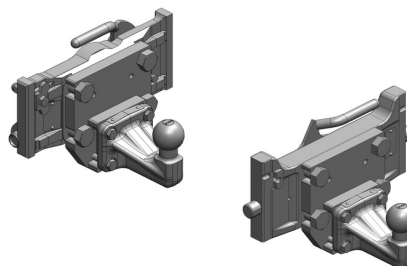

**Hubice mechanická  
s kolíkem ø 30 nebo 38 mm**

do r. 2001: **470,- EUR**  
05.3255.01

od r. 2002: **543,- EUR**  
03.3305.06

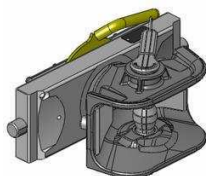

**Hubice automatická  
s kolíkem ø 30 mm**

do r. 2001: **400,- EUR**  
AKCE: 05.3251.32

od r. 2002: **780,- EUR**  
03.3301.021

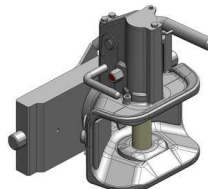

**Hubice automatická  
s kolíkem ø 38 mm**

do r. 2001: **840,- EUR**  
05.3253.321

od r. 2002: **780,- EUR**  
03.3303.221

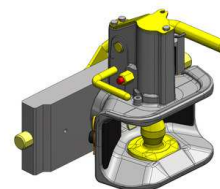

## Valtra série N, T, C, M, XM, 6000, 8000

**Hák hydraulický vč. tažné tyče**

**Cena: 3 570,- EUR** 00.419.50.5

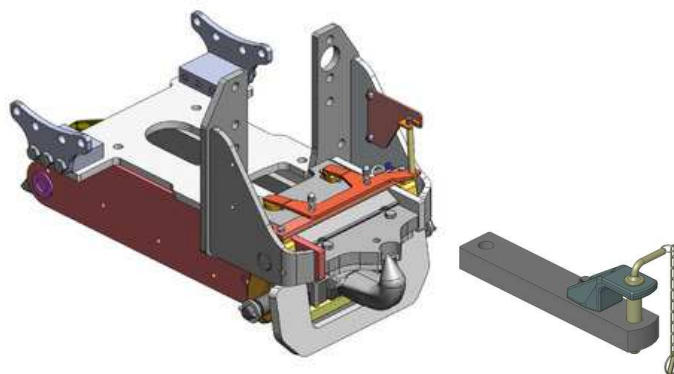

**Vložka K-80 do háku, zatížení 3 t**

**Cena: 1 444,- EUR** 00.423.00.0

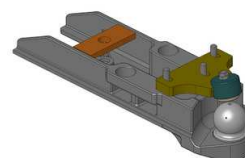

**Vložka K-80 do háku, zatížení 2 t,  
možnost připojení nuceného řízení**

**Cena: 981,- EUR** 00.427.01.0

